



Einbauanleitung Elektrosatz  
Anhängervorrichtung mit 12-N Steckdose  
lt. DIN/ISO Norm 1724

Instructions de montage du faisceau  
électrique pour crochet d'attelage  
conforme à la norme  
DIN/ISO 1724 prise 12-N

Fitting instructions electric wiringkit  
towbar with 12-N socket up to  
DIN/ISO norm 1724

Montage-handleiding elektrokabelset voor  
trekhaak met 12-N contactdoos  
vlg. DIN/ISO norm 1724

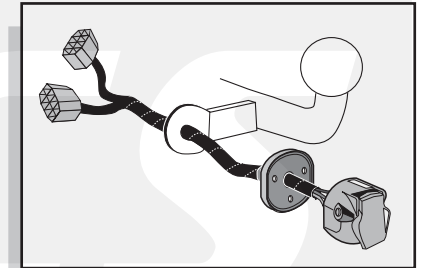

## IVECO DAILY 1999-

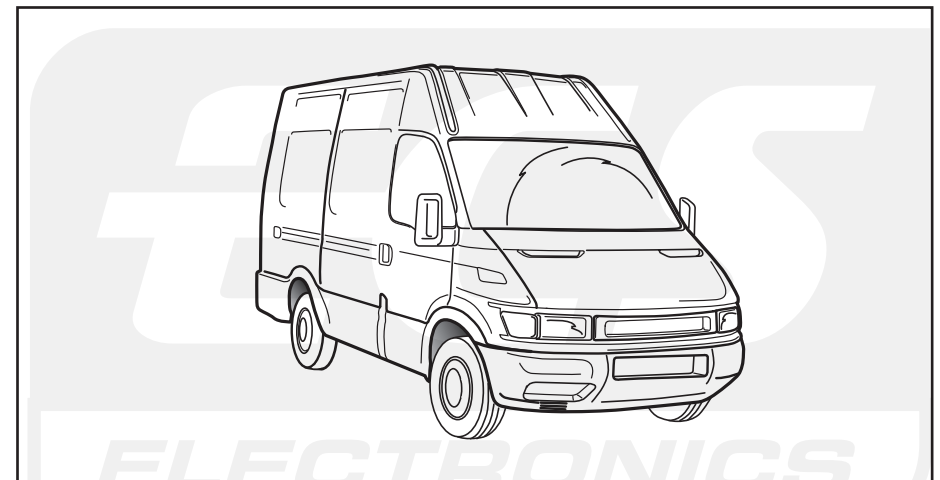

Bestel Nr.: IV-001-BB

\*Teilliste

\*List de pieces

\*Part list

\*Onderdelenlijst

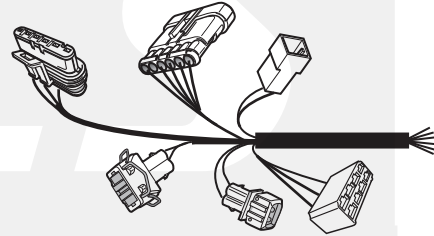
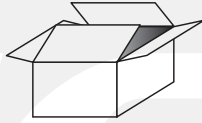

3x

5x

2x

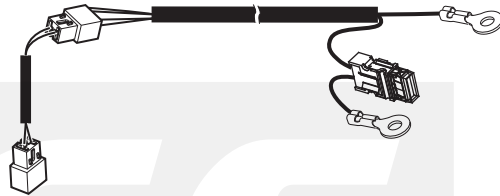
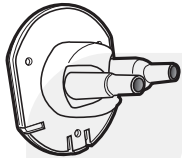
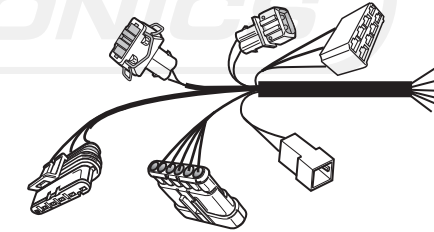
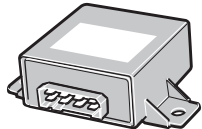

3x

3x

6x

4x

4x

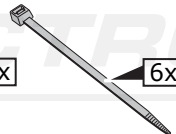

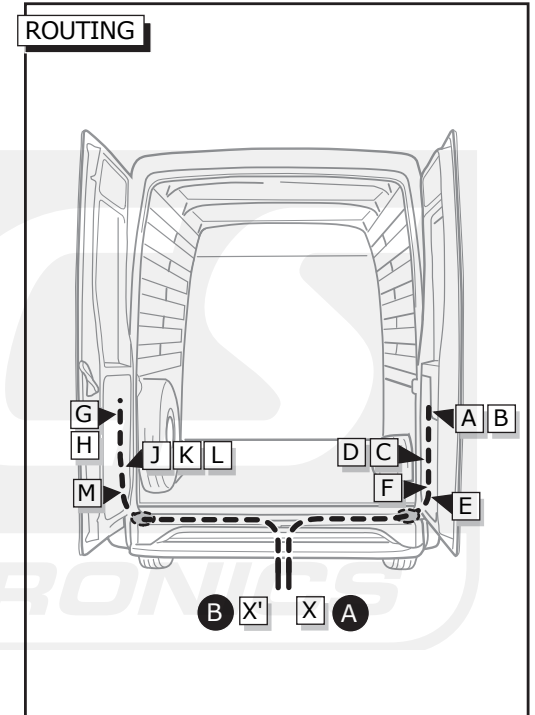
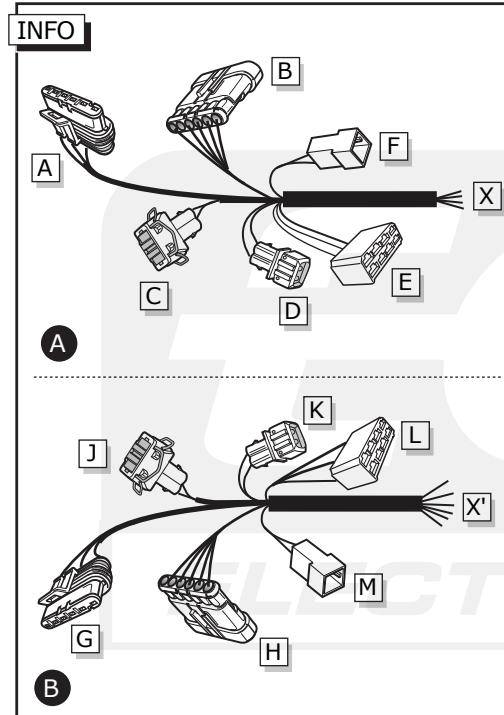
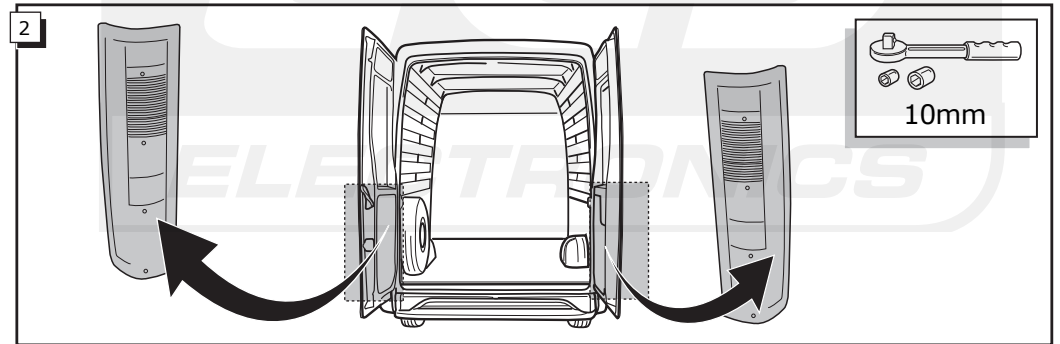
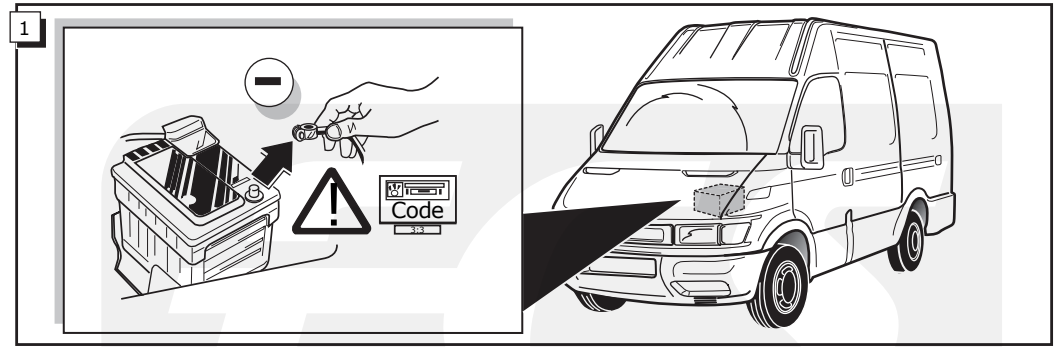

INFO

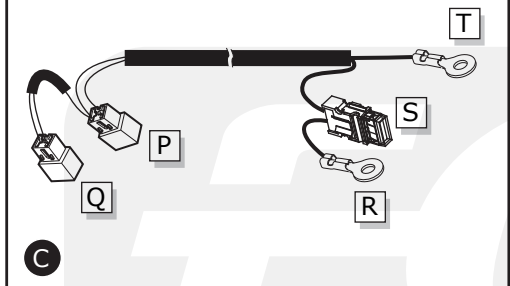

ROUTING

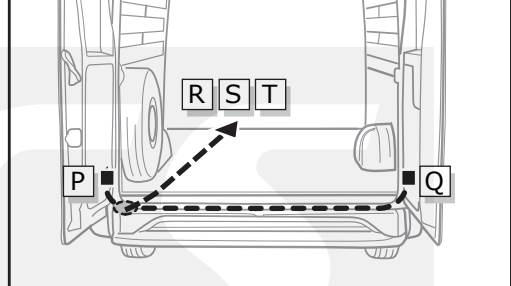

21

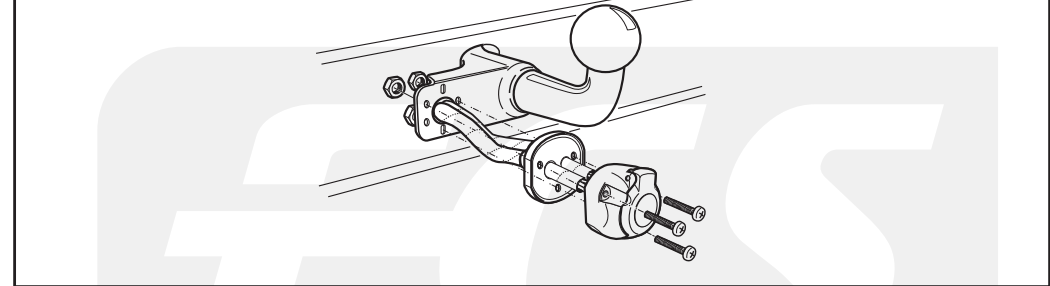

3

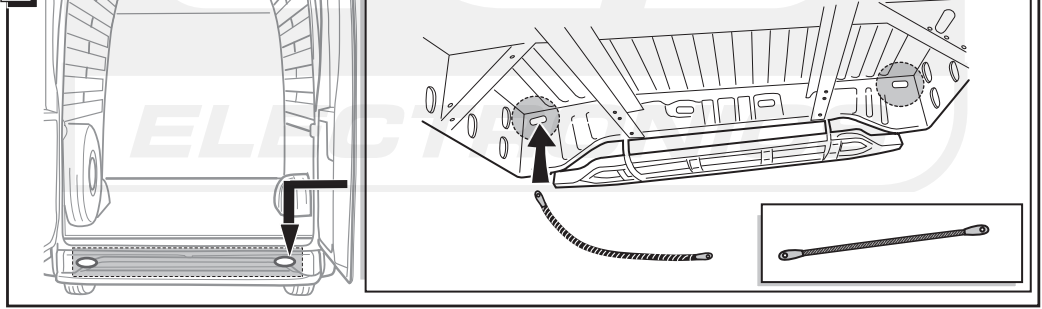

ROUTING

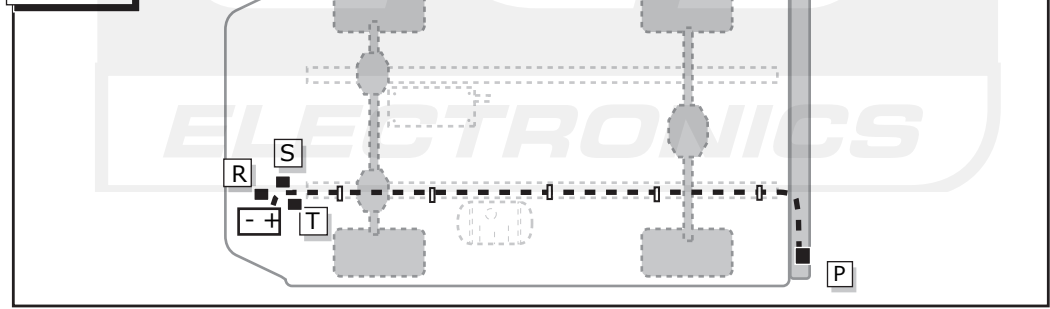

4

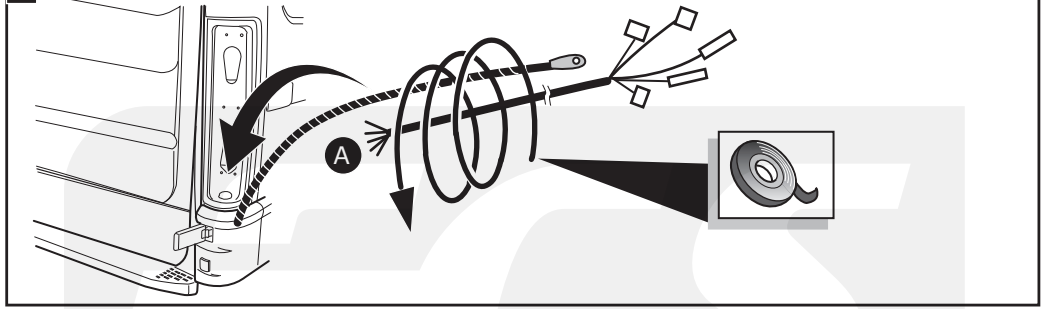

22

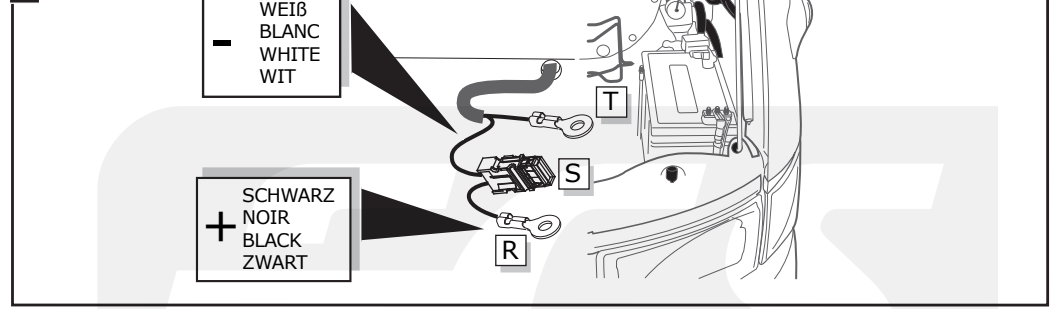

5

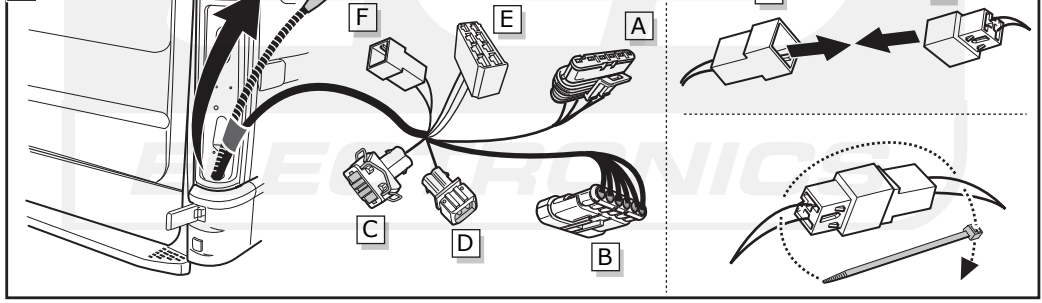

23

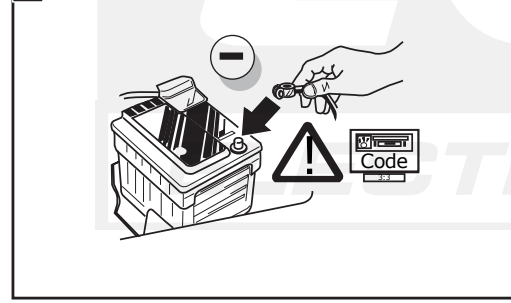

24

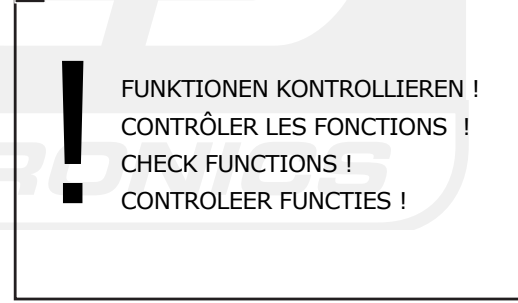

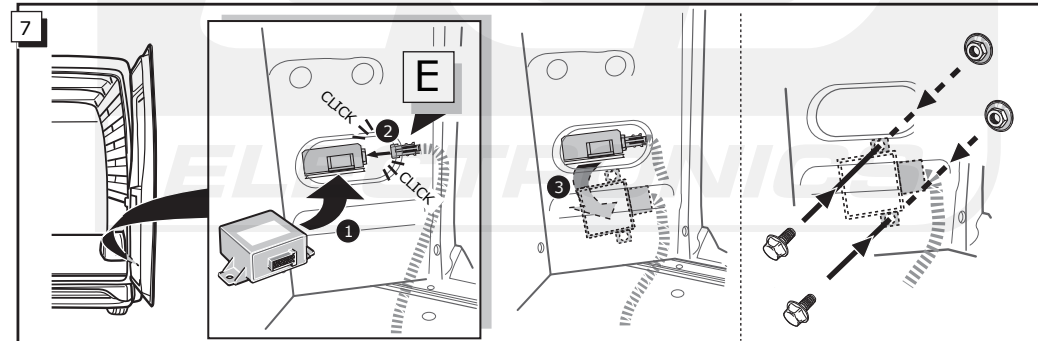
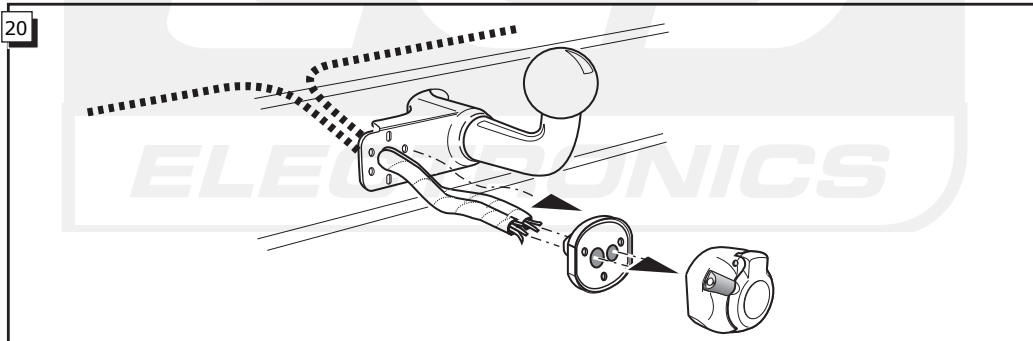
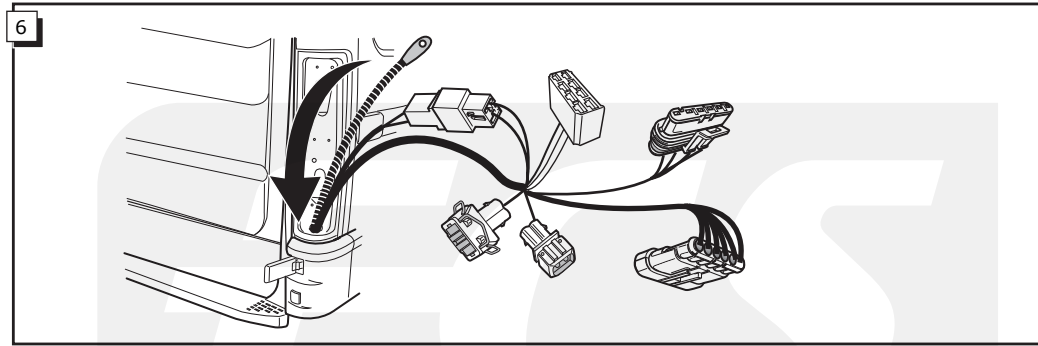
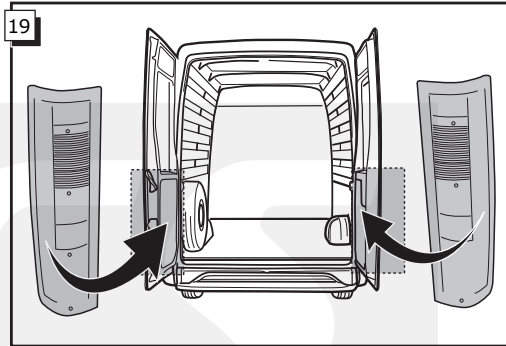
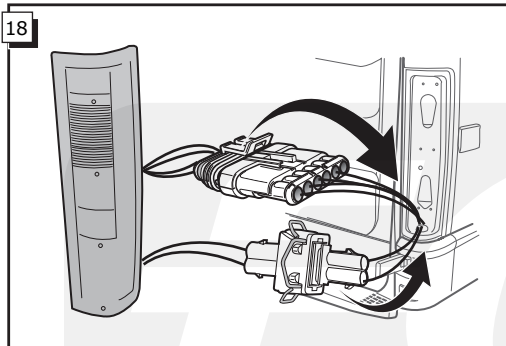

**INFO** Anschluß Steckdose / Connection de la prise / Socket connection / Contactdoos aansluiting

DIN/ISO 1724		(D)	(F)	(GB)	(NL)
	1/L	gelb	jaune	yellow	geel
	2	blau	bleu	blue	blauw
	3/31	weiß	blanc	white	wit
	4/R	grün	vert	green	groen
	5/58-R	braun	marron	brown	bruin
	6/54	rot	rouge	red	rood
	7/58-L	schwarz	noir	black	zwart
	8/58-b	grau	gris	grey	grijs

