



3er Limousine G20

03/19 →



3er Touring G21

09/19 →

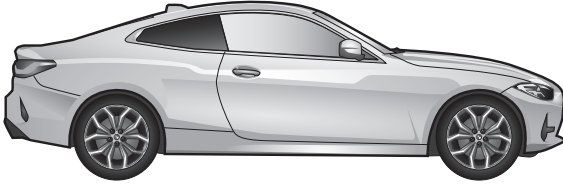

4er Coupé G22
4er Cabrio G23

10/20 →
03/21 →

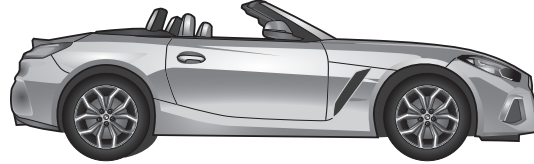

Z4 G29

11/18 →



Elektro-Einbausatz für Anhängerkupplung / 13-polig / 12 Volt / ISO 11446

Einbauanleitung



Electric wiring kit for towbars / 13-pin / 12 Volt / ISO 11446

Fitting instructions



Faisceau pour attelage / 13 broches / 12 Volt / ISO 11446

Instructions de montage



Cablaggio elettrico per ganci di traino / 13 poli / 12 Volt / ISO 11446

Istruzione di montaggio



Kits eléctricos para enganches de remolques / 13 pins / 12 Volt / ISO 11446

Instrucciones de montaje



Elektro-inbouwset voor aanhangerkoppeling / 13-polig / 12 Volt / ISO 11446

Montagehandleiding

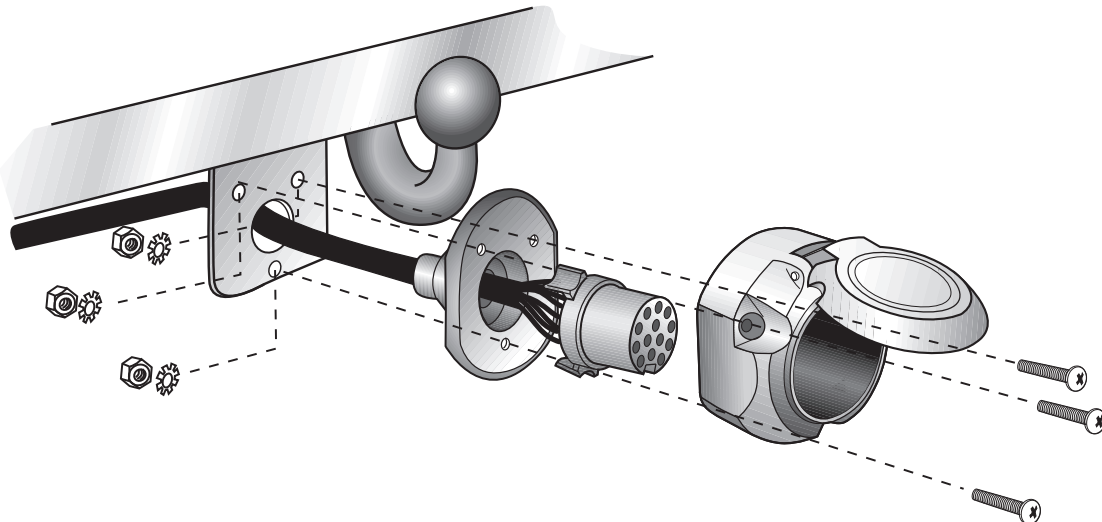



WICHTIG!

D

Der Einbau dieses Elektrosatzes muß von einer Fachwerkstatt oder einer entsprechend qualifizierten Person durchgeführt werden.

Vor Beginn aller Montagearbeiten muß die Einbau-Anleitung komplett gelesen und verstanden werden! Bei Fragen kontaktieren Sie bitte die in der Fusszeile genannte Hotline! Stellen Sie sicher, dass das Fahrzeug vom Hersteller für Anhängerbetrieb freigegeben ist! Vergewissern Sie sich, dass E-Satz- und Fahrzeugdaten übereinstimmen und definitiv miteinander kompatibel sind!

Nach Einbau des Elektrosatzes ist die Einbau-Anleitung zwingend den Serviceunterlagen des Fahrzeugs beizulegen! Sie enthält mitunter wichtige Informationen für zukünftig eventuell zu wiederholende Diagnose- oder Freischaltungsprozesse!

Bei unsachgemäßer Anwendung oder Veränderung des Elektrosatzes bzw. der darin befindlichen Bauteile erlischt jeder Anspruch auf Gewährleistung.

Beim Fahren ohne Anhänger oder Ladungsträger müssen ggf. verwendete Adapter immer aus der Steckdose entfernt werden.

Bei Anhängern oder Ladungsträgern ohne Nebelschlussleuchte ist eine uneingeschränkte Funktionalität des E-Satzes zum Teil nicht gewährleistet. In diesen Fällen bitte unbedingt Nebelschlussleuchte am Anhänger nachrüsten!

Für technische bzw. elektronische Änderungen, sowie Softwareupdates, welche nach erstmaliger Inbetriebnahme des Elektrosatzes vom Fahrzeughersteller durchgeführt werden und beispielsweise zu Fehlfunktionen der Anhängersteckdose oder deren Peripherie führen, übernehmen wir keinerlei Gewährleistung!

Je nach Art des im E-Satz verwendeten Anhängermoduls ist eine Interaktion mit dem Fahrzeugbordnetz nur eingeschränkt oder gar nicht möglich. Mit den spezifischen Diagnosesystemen der Fahrzeughersteller kann nicht auf modulinterne Fehlerspeicher zugegriffen werden.

Fehlerprotokolle in Bezug auf Anhängerbetrieb, die während eines Prüfprozesses mit den Diagnosesystemen der Fahrzeughersteller generiert werden, sind mitunter auf eine nicht ordnungsgemäße Freischaltung für Anhängerbetrieb zurückzuführen.

Wir empfehlen

→ die Auswertung der fahrzeugseitigen Fehlerspeicher sowie ggf. die Instandsetzung aller gelisteten Defekte vor Beginn aller Montagearbeiten!

→ das Anhängermodul ggf. vom Leitungssatz zu trennen und den Diagnoseprozess noch einmal zu starten!

→ die Fehlersuche bei Funktionsproblemen auf max. 0,5 Stunden zu begrenzen und sich danach an unsere Hotline zu wenden!

Die Prüfung der Anhängersteckdose muß mit einem realen Anhänger oder Ladungsträger erfolgen. Anhänger-Prüfgeräte müssen über Lastwiderstände verfügen. Einfache Dioden-Prüfstecker sind für eine ordentliche Prüfung aller Funktionen nicht geeignet!

Änderungen bezüglich Konstruktion, Ausstattung, Farbe sowie Irrtum vorbehalten. Alle Angaben und Abbildungen sind unverbindlich. Der in Deutsch gehaltene Text in dieser Einbau-Anleitung ist bindend!



IMPORTANT!

GB

This electric kit has to be installed by a professional workshop or a suitably qualified person. The installation instructions must have been read and fully understood before the start of any installation. Please contact the hotline shown in the footer should you have any questions!

Make sure that the vehicle is approved for operation with a trailer by the manufacturer! Check that the electric kit and vehicle data correlate and are definitely compatible with each other!

Following installation of the electric kit, the installation instructions must be kept together with the vehicle's service documents! They contain important information for any repeated diagnosis or activation processes that may be necessary in future!

All warranty claims will be forfeited if the electric kit or components contained therein are used incorrectly or modified.

When driving without a trailer or load carrier, any adapters that have been used must always be unplugged from the socket.

In the case of trailers or load carriers without rear fog lights, an unqualified function of the electric kit cannot be guaranteed in some cases. In such cases, please retrofit rear fog lights on the trailer!

We can assume no warranty or guarantee for technical and electrical modifications or software updates carried out by the vehicle manufacturer following the initial commissioning of the electric kit and which, for example, may lead to malfunctions in the trailer socket or its peripheral equipment!

Depending on the type of trailer module used in the electric kit, interaction with the vehicle's electrical system may be limited or even impossible. The error memory inside the module cannot be accessed with the specific diagnostic system of the vehicle manufacturer.

Error logs relating to the trailer mode that are generated during a test process with the vehicle manufacturer's diagnostic system are sometimes due to an incorrect activation for the trailer mode.

We recommend

→ an analysis of the vehicle's error memory and possibly the repair of all listed faults before the start of the installation!

→ possibly disconnecting the trailer module from the lead set and re-starting the diagnosis process!

→ limiting troubleshooting in the event of malfunctions to a max. of 0.5 hours and then contacting our hotline!

The trailer socket must be tested with a real trailer or load carrier. Trailer testers must have load resistors. Simple diode test plugs are not suitable for a proper test of all functions!

Subject to changes with respect to design, equipment, colour and error. All of the data and illustrations are without obligation.

The German text in these installation instructions is binding!



IMPORTANT!

F

Le montage de ce kit de connexion électrique doit être effectué par un atelier spécialisé ou une personne possédant la qualification correspondante. Avant de débiter toute opération de montage, il est indispensable d'avoir lu et compris intégralement les consignes de montage! Pour toute question, veuillez contacter la hotline indiquée en pied de page!

Assurez-vous que le véhicule est autorisé en mode remorque par le constructeur! Assurez-vous que le kit de connexion électrique et les données du véhicule correspondent bien et sont formellement compatibles!

Une fois le kit de connexion électrique monté, joindre impérativement les consignes de montage aux documents de service du véhicule! Elles peuvent comporter des informations importantes pour les processus de diagnostic ou d'activation qui devront éventuellement être répétés ultérieurement!

Toute utilisation ou modification inappropriée du kit de connexion électrique ou des pièces se trouvant à l'intérieur de celui-ci fait perdre toute prétention à une garantie.

Pour la conduite sans remorque ni support de chargement, il faudra toujours au préalable retirer de la prise l'adaptateur utilisé le cas échéant.

Pour les remorques ou supports de marchandises sans feu brouillard arrière, une fonctionnalité complète du kit de connexion électrique n'est pas entièrement garantie. Dans ces cas, compléter impérativement l'équipement en rajoutant un feu arrière brouillard sur la remorque!

Nous déclinons toute responsabilité pour les modifications techniques ou électroniques, ainsi que pour les mises à jour logicielles réalisées après la mise en service initiale du kit électronique du constructeur du véhicule et pouvant provoquer par exemple des dysfonctionnements de la prise de courant de la remorque ou de sa périphérie!

Suivant le type de module de remorque utilisé dans le kit électronique, une interaction avec le réseau de bord du véhicule n'est pas possible ou ne l'est que dans certaines limites. Il est impossible d'accéder aux mémoires d'erreurs internes avec les systèmes de diagnostic spécifiques des constructeurs de véhicules.

Les procès-verbaux d'erreurs concernant le fonctionnement de la remorque qui ont été générés durant un processus de contrôle avec les systèmes de diagnostic des constructeurs de véhicules sont parfois attribuables à une activation non conforme pour le fonctionnement de la remorque.

Nous recommandons

→ d'analyser les mémoires d'erreurs du véhicule ainsi qu'éventuellement de réparer toutes les défaillances mentionnées avant le commencement de tous les travaux de montage!

→ de séparer le module remorque le cas échéant du jeu de câbles et de remettre en marche encore une fois le processus de diagnostic!

→ de limiter la recherche d'erreurs à 0,5 h maximum en cas de problèmes de fonctionnement et de s'adresser ensuite à notre hotline!

La vérification de la prise de remorque doit être faite avec une véritable remorque ou un véritable support de marchandises. Les appareils de vérification de la remorque doivent disposer d'une résistance de charge. Les simples fiches de contrôle à diode ne conviennent pas pour vérifier correctement toutes les fonctions!

Sous réserve de modifications sur le plan de la construction, de l'équipement, de la couleur ainsi que d'erreurs. Toutes les informations et illustrations sont fournies sans engagement. Le texte en allemand dans cette notice d'installation fait foi!



IMPORTANTE!



Il montaggio di questo gruppo elettronico deve essere effettuato esclusivamente da un'officina specializzata o da personale debitamente qualificato. Prima dell'inizio di tutti i lavori di montaggio, accertarsi di avere letto e compreso le istruzioni di montaggio complete. In caso di domande, contattare il numero verde indicato a piè di pagina!

Accertarsi che il veicolo sia abilitato dal costruttore per il funzionamento con rimorchio. Assicurarsi che i dati del veicolo e del gruppo elettronico coincidano e siano compatibili tra di loro al 100%!

Dopo avere effettuato il montaggio del gruppo elettronico, la documentazione di montaggio deve essere assolutamente allegata alla documentazione di assistenza del veicolo! Essa contiene, tra l'altro, informazioni per i processi di diagnosi o di attivazione da ripetere eventualmente in futuro!

In caso di utilizzo scorretto o modifica del gruppo elettronico o dei componenti ivi contenuti, decade ogni diritto di garanzia!

Se si viaggia senza rimorchio o piattaforma di carico, gli adattatori eventualmente utilizzati devono essere sempre scollegati dalla presa.

Con rimorchi o piattaforme di carico senza faro retronebbia, non è sempre garantita una funzionalità illimitata del gruppo elettronico. In questi casi è indispensabile aggiungere al rimorchio i fari retronebbia!

Non concediamo alcuna garanzia per modifiche tecniche o elettroniche, aggiornamenti software che dopo la prima messa in funzione del gruppo elettronico vengono effettuate dal costruttore del veicolo e, ad esempio, possono causare malfunzionamenti della presa del rimorchio o delle sue periferiche!

A seconda del tipo di modulo rimorchio utilizzato nel gruppo elettronico, l'interazione con la rete di bordo del veicolo è possibile solo parzialmente o non è affatto possibile. Con i sistemi di diagnosi specifici dei costruttori di veicoli, non è possibile accedere alla memoria errori interna al modulo.

I protocolli di errore riferiti al funzionamento con rimorchio, generati durante un processo di collaudo con i sistemi di diagnosi dei costruttori di veicoli, sono da ricondurre, tra l'altro, a un'attivazione non corretta per funzionamento con rimorchio.

Consigliamo

- di effettuare assolutamente l'analisi della memoria errori sul veicolo ed eventualmente la riparazione di tutti i difetti riscontrati, prima di iniziare qualsiasi lavoro di montaggio;
- di scollegare eventualmente il modulo rimorchio dalla serie di cavi e di avviare nuovamente il processo di diagnosi;
- di limitare la ricerca errori in caso di problemi di funzionamento a max. 0,5 ore, quindi di rivolgersi al nostro numero verde.

Il controllo della presa del rimorchio deve essere effettuato con un rimorchio o una piattaforma di carico reali. I dispositivi di collaudo dei rimorchi devono essere provvisti di resistenze di carico. Le spine di collaudo a diodi semplici non sono adatte per un controllo corretto di tutte le funzioni!

Con riserva di modifiche strutturali, di dotazione, colore ed errori. Tutti i dati e le figure non sono vincolanti. Il testo in tedesco in queste istruzioni di montaggio è vincolante!



¡IMPORTANTE!



El montaje de este kit eléctrico se debe llevar a cabo en un taller especializado o por parte de una persona correspondientemente cualificada.

¡Antes de comenzar cualquier trabajo de montaje se deben haber leído y entendido las instrucciones de montaje por completo! ¡En caso de preguntas, rogamos póngase en contacto con la línea directa indicada en el pie de página!

¡Asegúrese de que el vehículo esté homologado por el fabricante para el servicio con remolque! ¡Compruebe que los datos del kit eléctrico concuerden con los datos del vehículo y que sean definitivamente compatibles!

¡Después de haber montado el kit eléctrico es obligatorio adjuntar las instrucciones de montaje a los documentos de servicio del vehículo! ¡A menudo contienen información requerida para futuras operaciones de diagnóstico o habilitación que pueden ser necesarias!

El uso indebido o la modificación del kit eléctrico o de los componentes en su interior supone la extinción de cualquier derecho de garantía.

Si se usa el vehículo sin remolque o plataforma de carga, siempre se deberán separar los adaptadores utilizados del enchufe.

En el caso de remolques o plataformas de carga sin luz antiniebla trasera no se puede garantizar una completa funcionalidad del kit eléctrico en todos los casos. ¡En tal caso rogamos reequipar el remolque con una luz antiniebla trasera sin falta!

¡No asumiremos garantía alguna por modificaciones técnicas y/o electrónicas o actualizaciones de software que se lleven a cabo después de la primera puesta en servicio del kit eléctrico por parte del fabricante del vehículo y que puedan dar lugar, por ejemplo, a fallos de funcionamiento de la base eléctrica para el remolque o los periféricos!

En función del tipo de módulo para remolques CFC utilizado en el kit eléctrico no se podrá interactuar con el sistema eléctrico de a bordo o solo de forma limitada. Los sistemas de diagnóstico específicos de los fabricantes de vehículos no permiten el acceso a las memorias de fallos internas del módulo.

Los protocolos de fallos referidos al servicio con remolque, que se generen con sistemas de diagnóstico de los fabricantes de vehículos durante un proceso de inspección, a veces son el resultado de un desbloqueo incorrecto para el servicio con remolque.

Recomendamos:

- ¡evaluar las memorias de fallos del vehículo y eliminar, en caso dado, todos los defectos enumerados antes de comenzar los trabajos de montaje!
- ¡separar el módulo para remolques del juego de cables en caso dado y volver a iniciar el proceso de diagnóstico!
- ¡limitar la búsqueda de fallos en caso de problemas de funcionamiento a un máximo de 0,5 horas y acudir entonces a nuestra línea de atención!

La caja de enchufe del remolque se debe comprobar con un remolque o una plataforma de carga real. Los equipos de comprobación de remolques deben estar equipados con resistencias de carga. ¡Las clavijas de prueba con diodos no son adecuadas para comprobar debidamente todas las funciones!

Queda reservado el derecho a realizar modificaciones constructivas, de equipamiento y color y de posibles errores. Todos los datos e ilustraciones se entienden sin compromiso. ¡La versión vinculante de estas instrucciones de montaje es la original en lengua alemana!



BELANGRIJK!



De montage van deze elektrische set moet worden verricht door een bevoegde garage of een daarmee vergelijkbaar gekwalificeerd persoon.

Voorafgaand aan elke montage moet men de gebruiksaanwijzing volledig hebben gelezen en begrepen! Neemt u bij eventuele vragen contact op met de hotline die staat vermeld in de voettekst!

Let u erop dat het aanhängersysteem door de fabrikant van uw voertuig moet zijn aangesloten en/of geactiveerd! Zorg u ervoor dat u er zeker van bent dat de elektrische set en de specificaties van uw voertuig met elkaar overeenstemmen – en dat ze helemaal compatibel zijn!

Na de montage van de elektrische set is het absoluut noodzakelijk dat u de gebruiksaanwijzing bewaart bij de gegevens van de servicebeurten van uw voertuig! Deze informatie is vaak van groot belang voor toekomstige, eventueel periodieke, procedures voor diagnostiek, aansluiting en/of activatie!

In geval van ondeskundig gebruik en/of wijziging van de elektrische set en/of de daartoe behorende onderdelen vervalt elke garanties.

Zodra u zonder aanhanger of ladingdrager rijdt, moet u de desbetreffende adapters altijd loskoppelen van de stekkerdoos

Bij aanhängers en/of ladingdragers zonder mistachterlichten kan een onbeperkte functionaliteit van de elektrische set niet volledig worden gegarandeerd. In dergelijke gevallen moet u beslist extra mistachterlichten op de aanhanger aanbrengen!

Wij dragen geen enkele aansprakelijkheid voor technische en/of elektronische wijzigingen alsmede software-updates die worden verricht na de eerste inbedrijfstelling van de elektrische set door de autofabrikant en die bijvoorbeeld leiden tot fouten in het functioneren van de aanhangerstekkerdoos en/of de randapparatuur!

Afhankelijk van de soort aanhängersmodule die in de elektrische set wordt gebruikt, kan de interactie met het voertuignetwerk beperkt of zelfs onmogelijk zijn. Met de specifieke diagnostische systemen van de autofabrikant is geen toegang mogelijk tot foutenlogboeken die zich in de module zelf bevinden.

Foutrapportages ten aanzien van de werking van de aanhanger, die kunnen worden gegenereerd tijdens testprocedures door het diagnostische systeem van de autofabrikant, zijn soms te herleiden tot een incorrecte aansluiting en/of activering van het aanhängersysteem.

Wij raden u aan

- de foutrapportages van uw voertuig te inspecteren, en de nodige reparaties te verrichten, voor aanvang van elk montagewerk!
- uw aanhängersmodule indien nodig los te koppelen van de kabelset, waarna u de diagnoseprocedure opnieuw opstart!
- in geval van functionele problemen niet langer dan een half uur te zoeken naar een fout, maar contact op te nemen met onze hotline!

Het testen van de aanhängerstekkerdoos moet gebeuren met behulp van een daadwerkelijke aanhanger en/of ladingdrager. Testapparaten voor aanhängers moeten beschikken over belastingsweerstand. Eenvoudige diodetesters zijn niet geschikt voor de correcte inspectie van alle functies!

Aan deze informatie en afbeeldingen kunnen geen rechten worden ontleend. Wijzigingen voorbehouden ten aanzien van constructie, uitrusting, kleur en/of eventuele misrekening/vergingssing. De Duitstalige tekst van deze gebruiksaanwijzing is bindend!

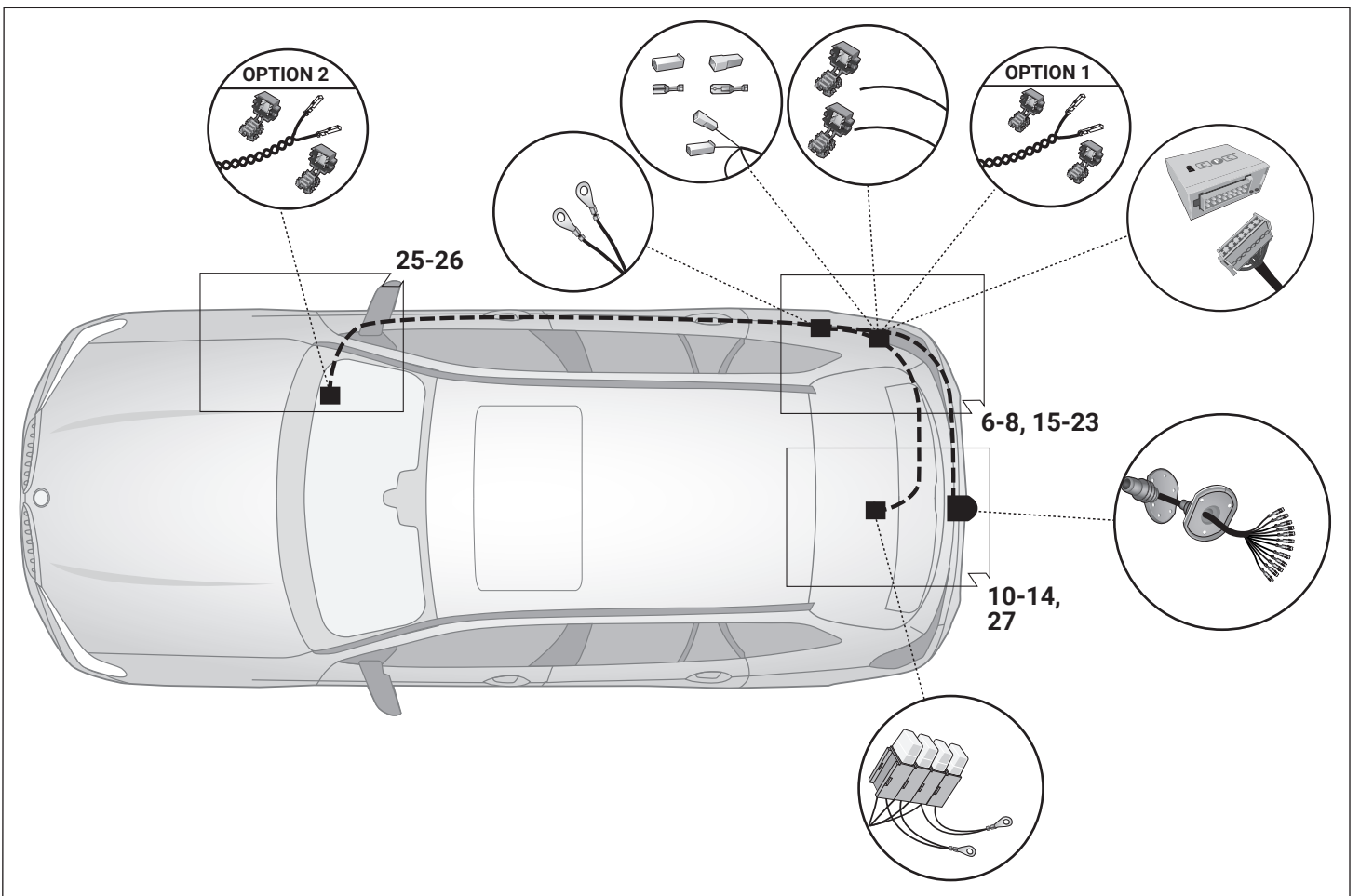
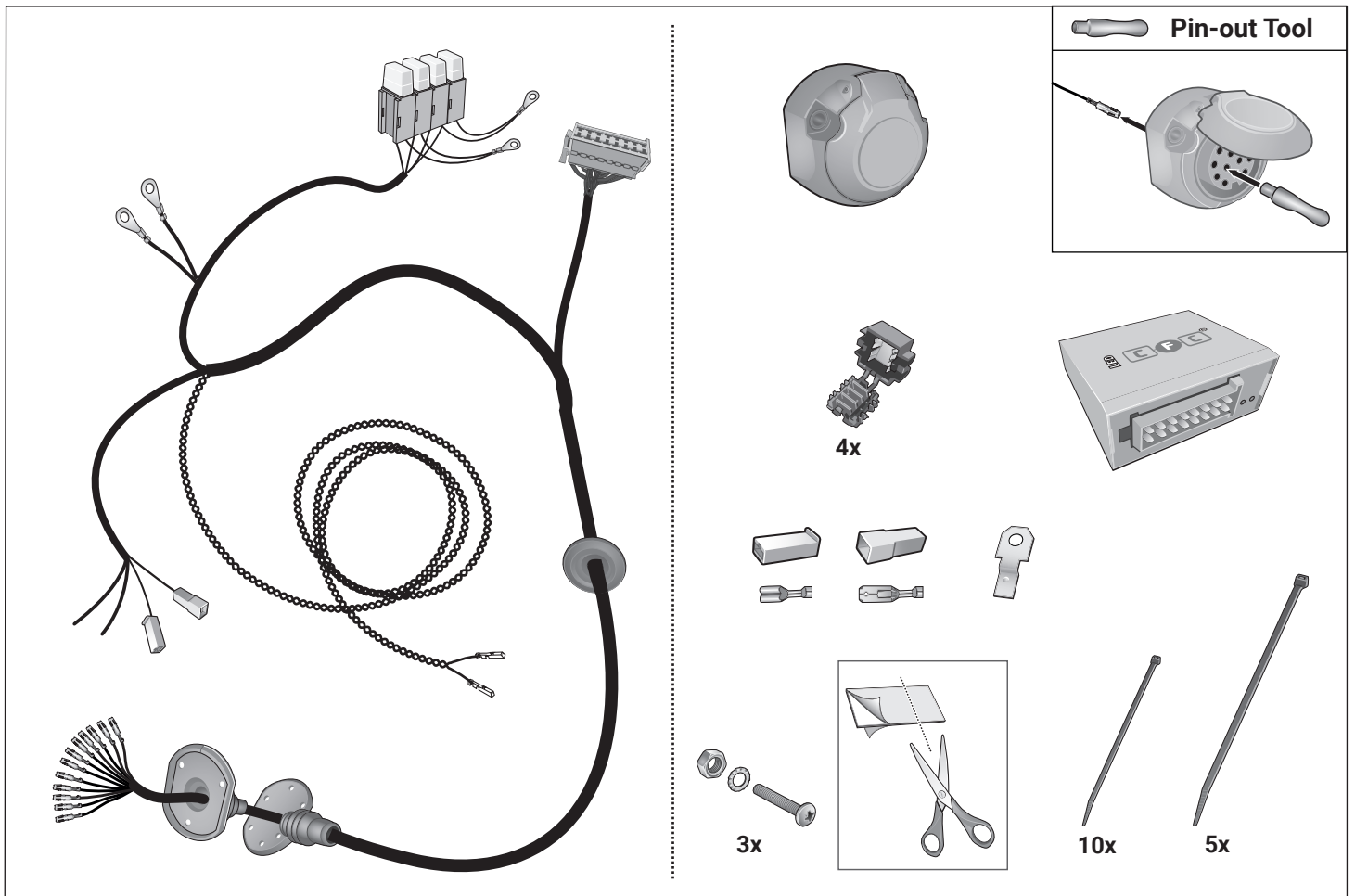

Werkzeuge - Tools - Outils - Utensile - Herramientas - Werktuigen

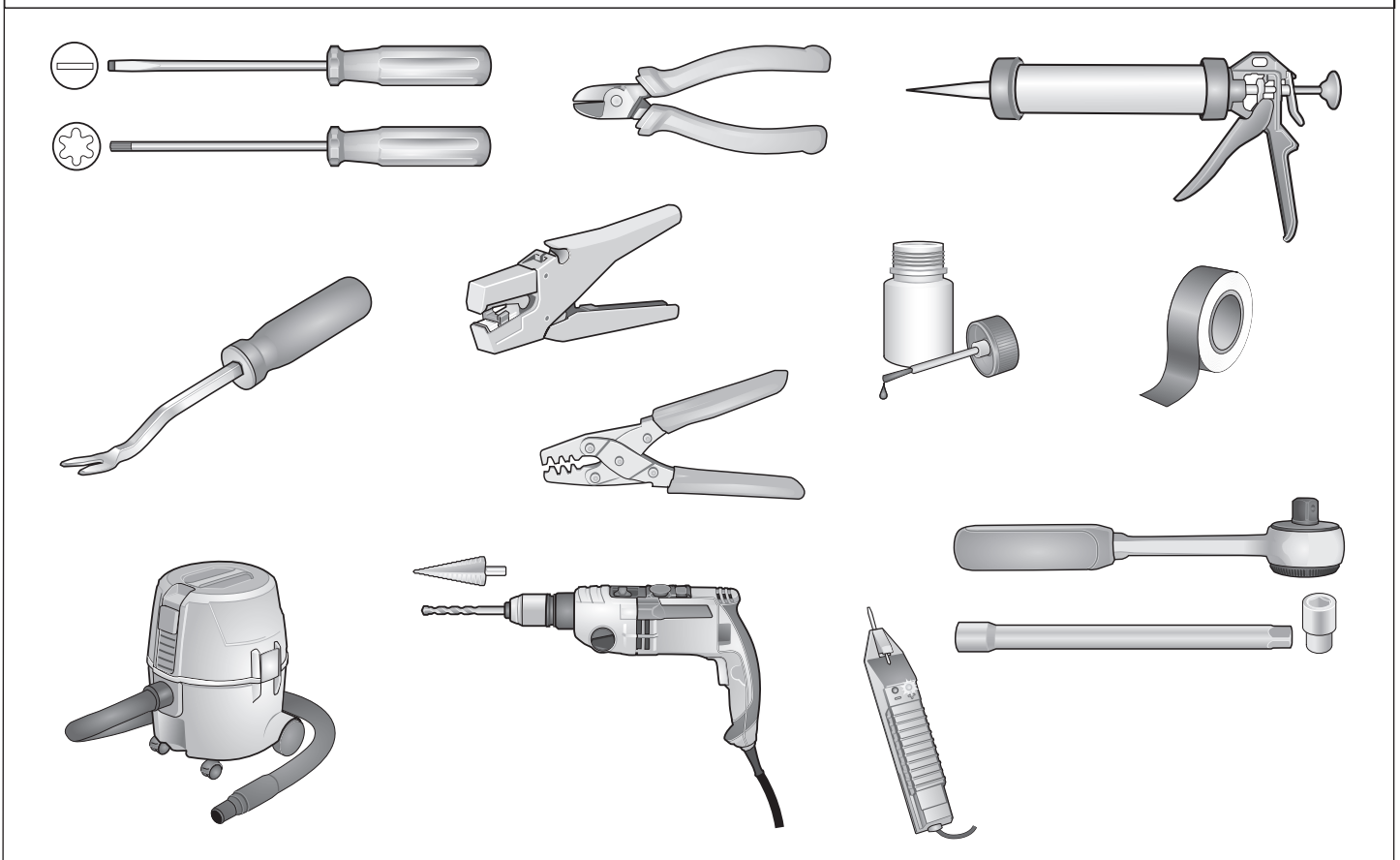

ACHTUNG!	ATTENTION!	ATTENTION!	ATTENZIONE!	¡ATENCIÓN!	ATTENTIE!
(D)	(GB)	(F)	(I)	(E)	(NL)
Die Kühlerleistung des Fahrzeuges muß bei Nachrüstung einer Anhängerkupplung möglicherweise erhöht werden! Bitte unbedingt Herstellerangaben beachten!!	The vehicle's cooling capacity may have to be increased when retrofitting a trailer coupling! You must observe the manufacturer's instructions!!	Il peut s'avérer nécessaire d'augmenter la puissance du radiateur du véhicule lorsque celui est équipé ultérieurement d'un attelage remorque! Respecter impérativement les instructions du constructeur!!	La capacità di raffreddamento del veicolo, quando si applica un gancio di traino, si deve possibilmente aumentare! Si prega di osservare tassativamente le indicazioni del produttore!!	¡Es posible que haya que aumentar la capacidad del radiador en caso de reequipar un acoplamiento de remolque! ¡Rogamos tener en cuenta las instrucciones de fabricante sin falta!	Het koelvermogen van het voertuig moet mogelijk worden verhoogd als achteraf een aanhangerkoppeling wordt aangebracht! Absoluut de fabrieksopgaven in acht nemen a.u.b.!!

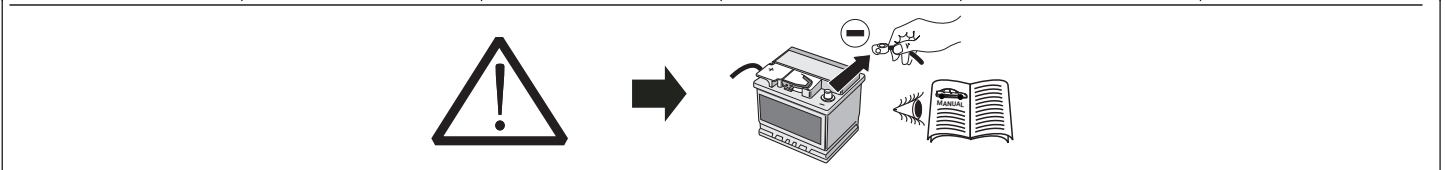

ACHTUNG!	ATTENTION!	ATTENTION!	ATTENZIONE!	¡ATENCIÓN!	ATTENTIE!
Um Störungen und Schäden am Bordnetz zu vermeiden, muß die Massepolklemme unbedingt vor Beginn aller Arbeiten von der Fahrzeugbatterie getrennt werden!	In order to avoid malfunctions and damage to the vehicle's electrical system the earth terminal must be disconnected from the vehicle's battery before starting work!	Afin d'éviter tout dysfonctionnement ou endommagement du circuit de bord, il est indispensable de débrancher la pince de masse de la batterie du véhicule avant le début de toute opération!	Per evitare disturbi e danni alla rete di distribuzione elettrica, l'espansione polare a massa deve essere assolutamente scollegata dalla batteria del veicolo prima dell'inizio dei lavori!	¡Para evitar fallos y defectos en el sistema eléctrico de a bordo es imprescindible separar al terminal de puesta a tierra de la batería del vehículo antes de realizar cualquier trabajo!	Om storingen en schade aan de elektrische bedrading te vermijden moet de massapoolklem absoluut vóór aanvang van alle werkzaamheden worden losgekoppeld van de voertuigaccu!
Insbesondere bei Arbeiten und Anschlüssen am CAN-Datenbus kann bei nicht abgeklemmter Batterie sowohl das Anhängermodul als auch das fahrzeugseitige Bordnetzsteuergerät beschädigt werden! Bitte Herstellervorschriften beim Ab- und Anklemmen der Fahrzeugbatterie beachten!	Both the trailer module and the vehicle's control unit for the electrical system can be damaged during work on the CAN data bus connections if the battery is not disconnected! Please pay attention to the manufacturer's instructions when disconnecting and reconnecting the vehicle's battery!	En particulier s'il s'agit de travaux et de branchements effectués sur le bus de données CAN, si la batterie n'est pas débranchée, le module remorque aussi bien que le dispositif de commande de circuit de bord du véhicule risquent d'être endommagés! Veuillez respecter les directives du fabricant lors du branchement et du débranchement de la batterie du véhicule!	In particolare durante i lavori e gli allacciamenti al bus di dati CAN, se la batteria non è scollegata si possono danneggiare sia la centralina rimorchio, sia la centralina della rete di distribuzione elettrica del veicolo! Attenersi alle indicazioni del costruttore per scollegare e ricollegare la batteria del veicolo!	¡Particularmente al realizar trabajos y conexiones al bus de datos CAN puede estropearse tanto el módulo para remolques como el regulador del sistema eléctrico de a bordo del vehículo si no se ha desconectado la batería! ¡Rogamos observar las instrucciones del fabricante al conectar y desconectar la batería del vehículo!	Vooral bij werkzaamheden aan en aansluitingen op de CAN-databus kan zowel de aanhangermodule als de voertuigzijdige regeleenheid voor de elektrische installatie beschadigd worden, als de accu niet ontkoppeld is! Fabrieksvoorschriften bij het vasten loskoppelen van de voertuigaccu in acht nemen a.u.b.!

3er Touring G21

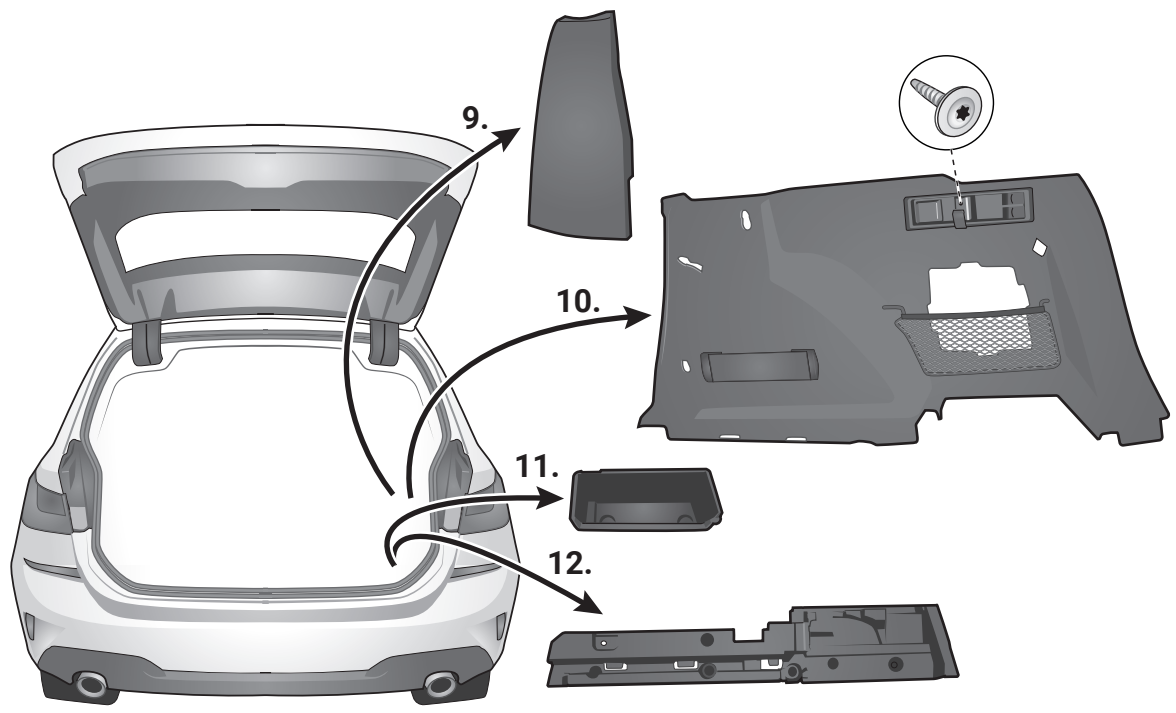
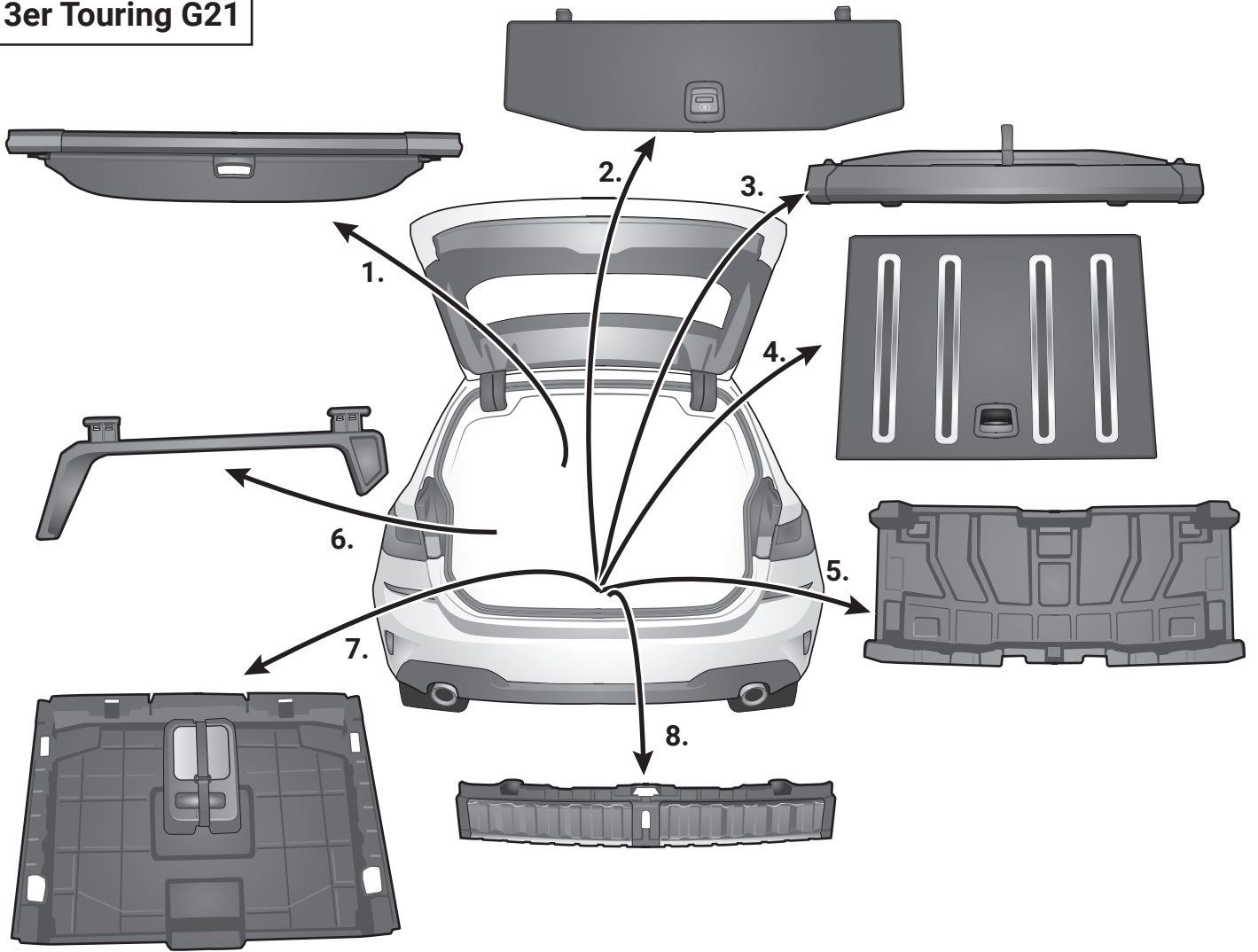

Z4 G29

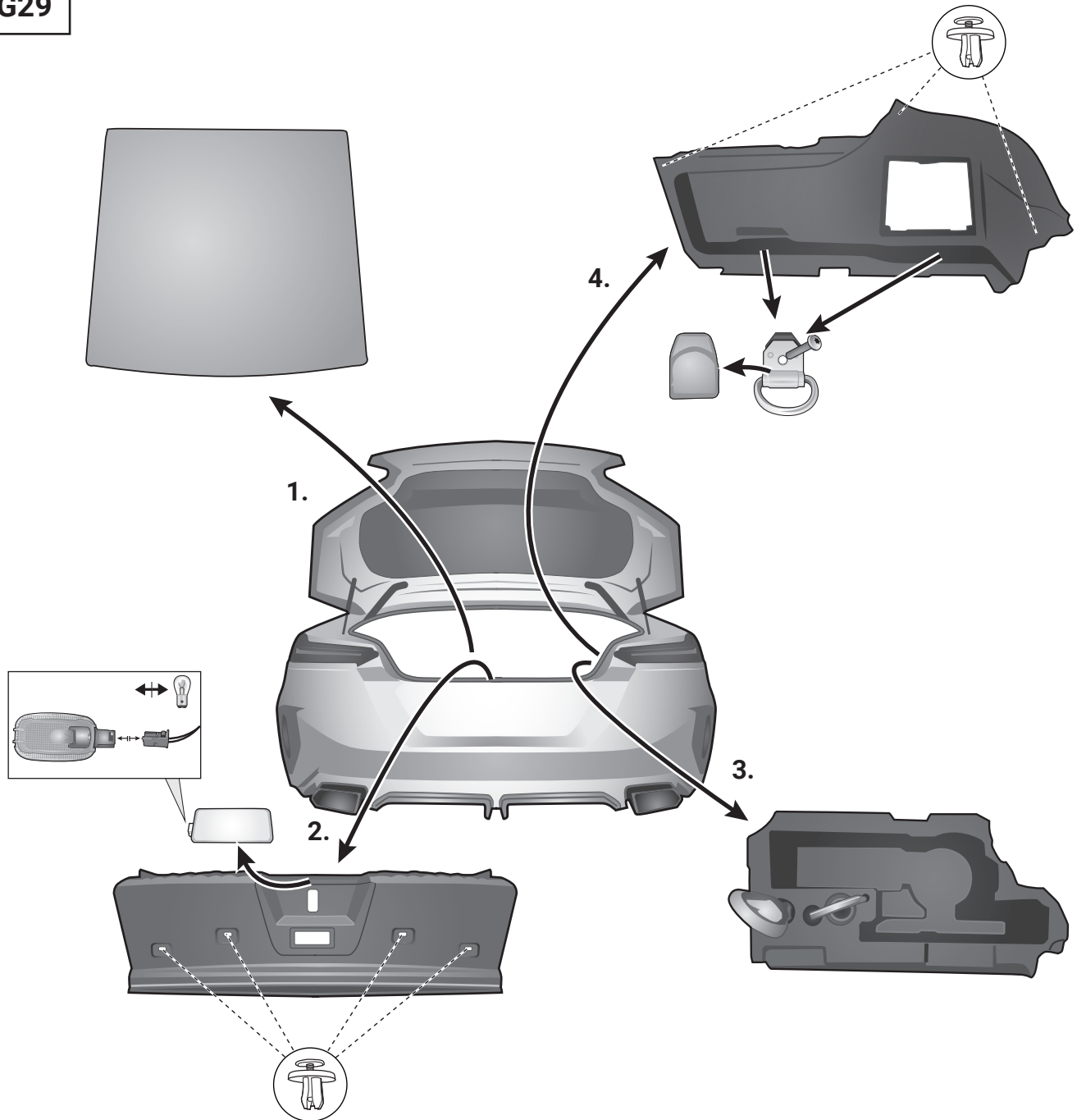

5

3er Limousine G20 / 4er Coupé G22 / Z4 G29

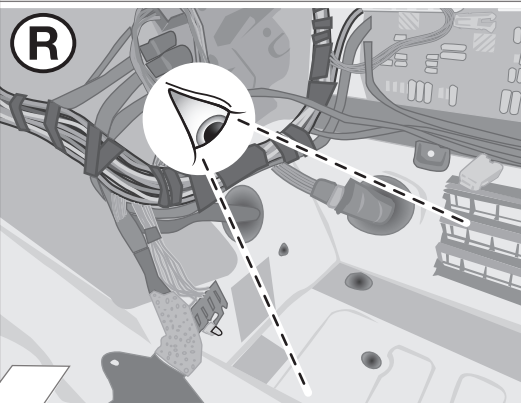

**Attention: Adblue tank
Be careful when drilling**

**Achtung: Vorsicht beim Bohren
"Adblue-Tank"!**

Ø 32 mm

6

4er Cabrio G23

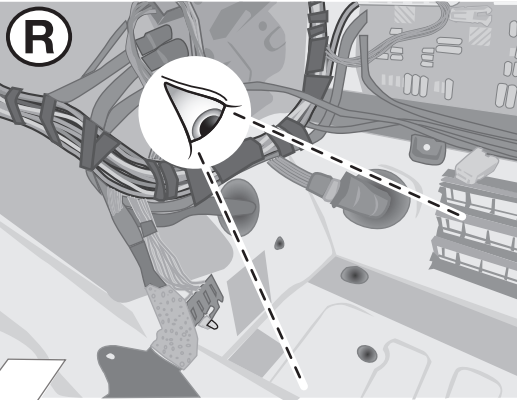

**Attention: Adblue tank
Be careful when drilling**
**Achtung: Vorsicht beim Bohren
"Adblue-Tank"!**

Ø 32 mm

7

3er Touring G21

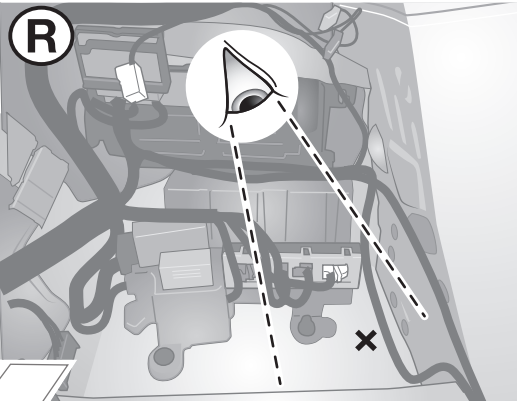

**Attention: Adblue tank
Be careful when drilling**
**Achtung: Vorsicht beim Bohren
"Adblue-Tank"!**

Ø 32 mm

8

9

10

	GB	D	E	F	I	P	NL	DK	N	S	FIN	CZ	H	PL
BK	Black	Schwarz	Negro	Noir	Nero	Preto	Zwart	Sort	Svart	Svart	Musta	Černá	Fekete	Czarny
RD	Red	Rot	Rojo	Rouge	Rosso	Vermelho	Rood	Rød	Rød	Röd	Punainen	Červená	Piros	Czerwony
GN	Green	Grün	Verde	Vert	Verde	Verde	Groen	Grøn	Grønt	Grön	Vihreä	Zelená	Zöld	Zielony
OR	Orange	Orange	Naranja	Orange	Arancione	Laranja	Oranje	Orange	Orange	Orange	Oranssi	Oranzová	Narancs	Pomarańczowy
VT	Violet	Violett	Violeta	Violet	Viola	Violeta	Violet	Violet	Fiolett	Violett	Violetti	Fialová	Ibolya	Fioletowy
PK	Pink	Pink	Pink	Rose	Rosa	Cor-de-Rosa	Paars	Pink	Pink	Rosa	Pinkki	Růžová	Rózsaszín	Różowy
BL	Blue	Blau	Azul	Bleu	Blu	Azul	Blauw	Blå	Blått	Blå	Sininen	Modrá	Kék	Niebieski
YL	Yellow	Gelb	Amarillo	Jaune	Giallo	Amarelo	Geel	Gul	Gult	Gul	Keltainen	Zlutá	Sárga	Żółty
WT	White	Weiss	Blanco	Blanc	Bianco	Branco	Wit	Hvid	Hvitt	Vit	Valkoinen	Bílá	Fehér	Biały
BR	Brown	Braun	Marrón	Brun	Marrone	Marrom	Bruin	Brun	Brunt	Brun	Ruskea	Hnědá	Barna	Brazowy
GY	Grey	Grau	Gris	Gris	Grigio	Cinzeno	Grijs	Grå	Grått	Grå	Harmaa	Sedá	Szürke	Szary

11

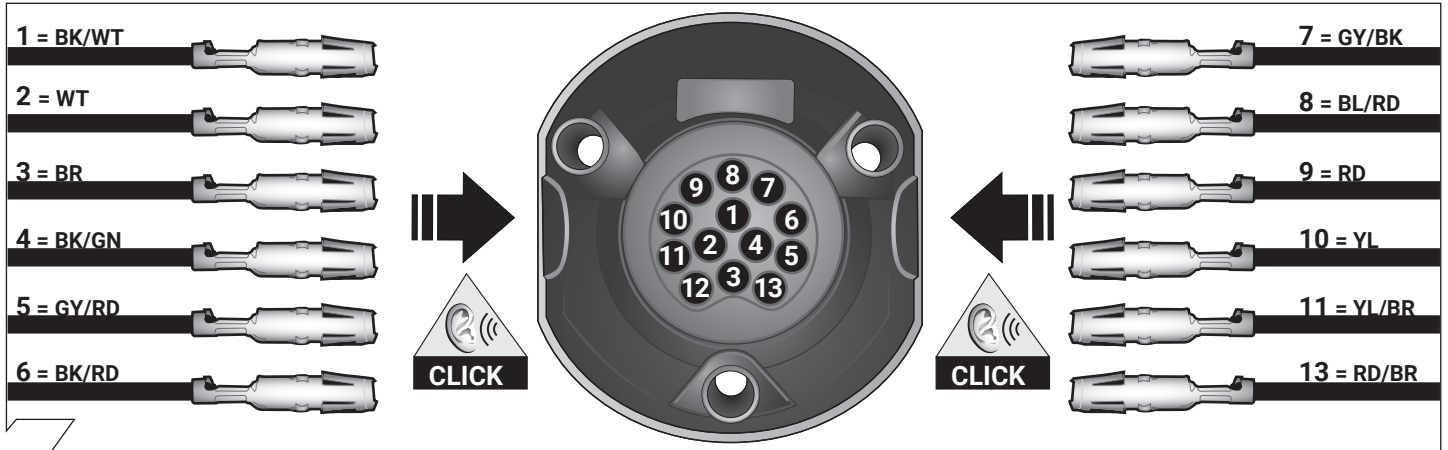

12

ISO 11446	Belegung der Steckdose / Maximale Ausgangsleistung Socket configuration / Maximum power output Correspondance des contacts de la prise / Puissance de sortie maximale Abbinamento della presa / Uscita di alimentazione massima Indeling van de stekkerdoos / maximaal uitgangsvermogen		
	1/L	BK/WT	21W
	2	WT	21W
	3/31	BR	
	4/R	BK/GN	21W
	5/58-R	GY/RD	52W
	6/54	BK/RD	63W
	7/58-L	GY/BK	52W
	8	BL/RD	42W
	9	RD	240W
	10	YL	180W
	11	YL/BR	
	12		
	13	RD/BR	

13

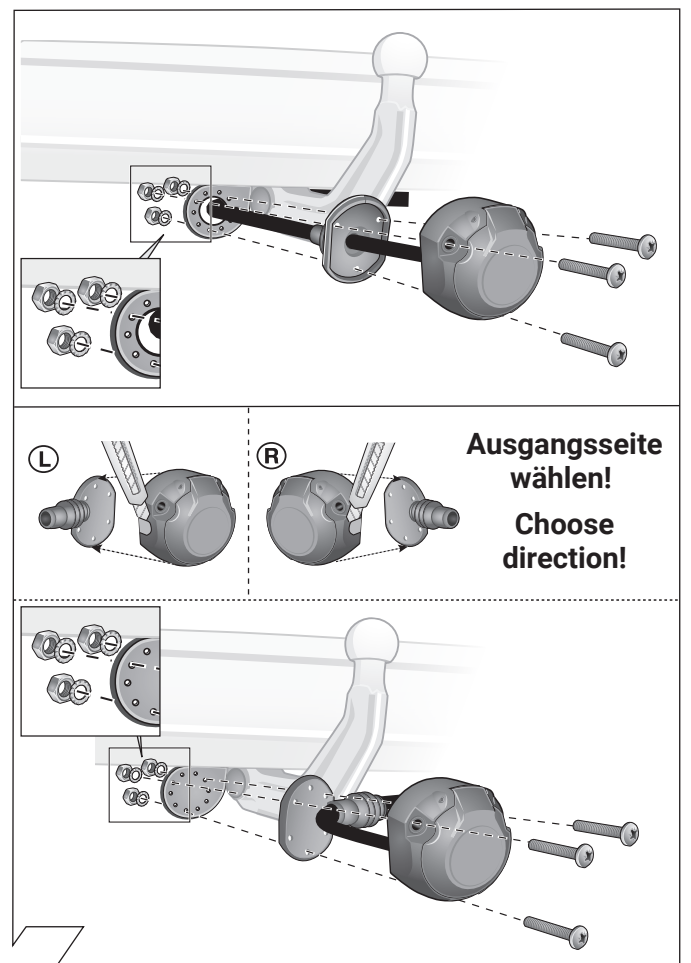

14

3er Limousine G20

(R)

Option 1

Option 2

Wichtig!
Unbedingt Hinweise aus Bild 1 beachten!

Important!
Please note informations in picture 1!

(R)

GN/GY

STOP

GN/GY

STOP

BK/YL

BL/BR

STOP

BL/BR

STOP

BK/GY

(R)

YL/BK

YL/BK

WT

GY

(R)

!

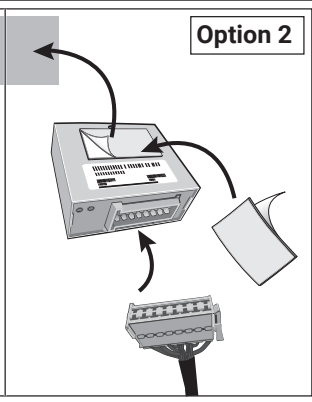
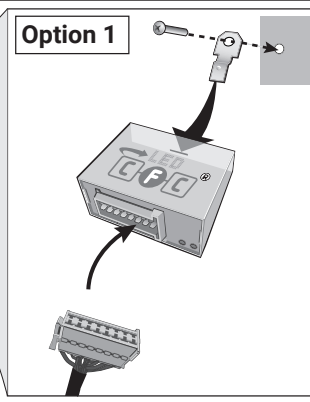
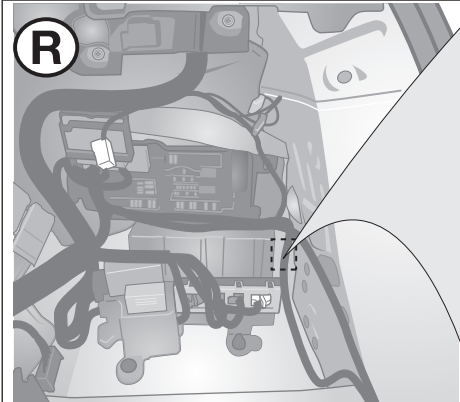

!

Wichtig!
Unbedingt Hinweise
aus Bild 1 beachten!

Important!
Please note
informations in
picture 1!

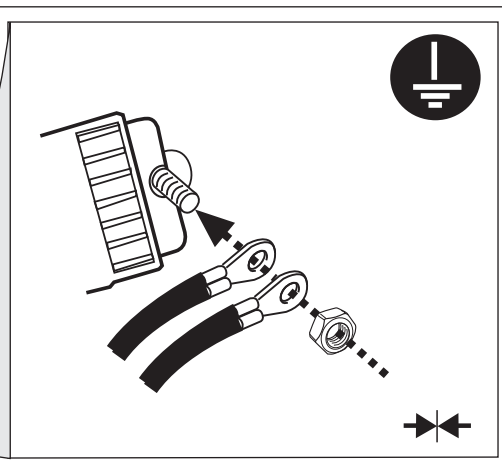
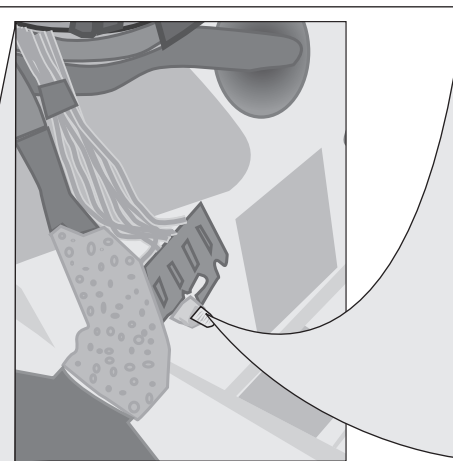
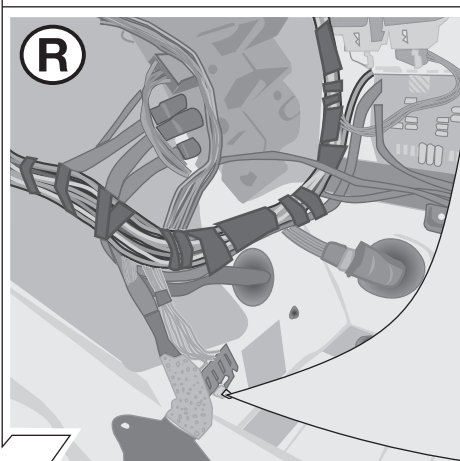
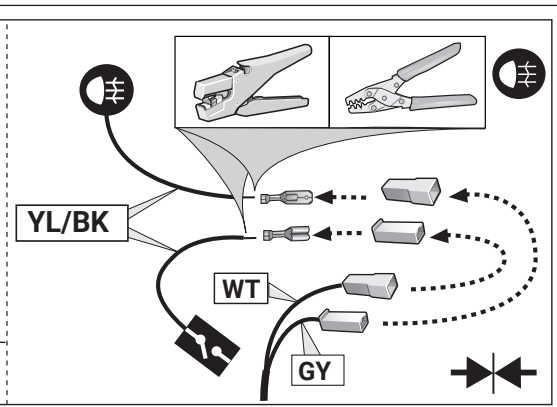
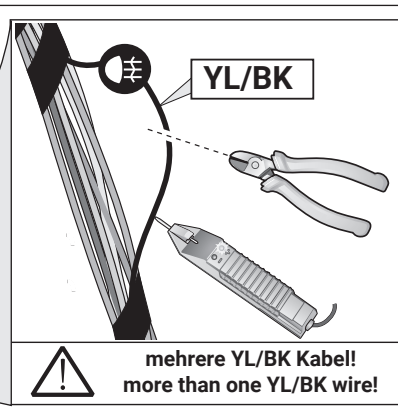
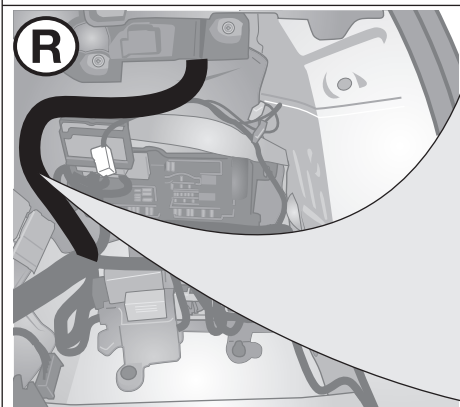
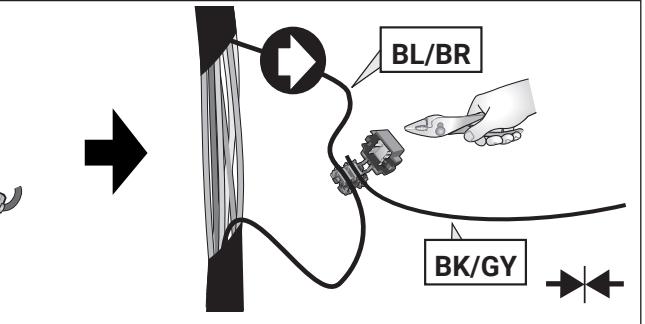
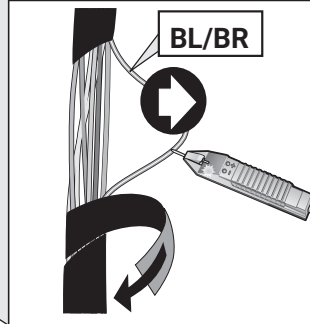
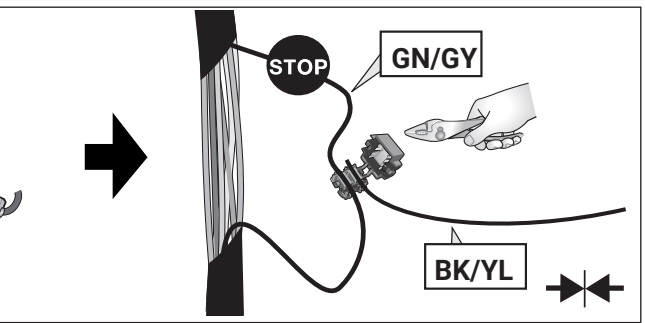
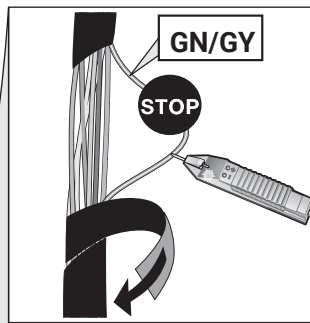
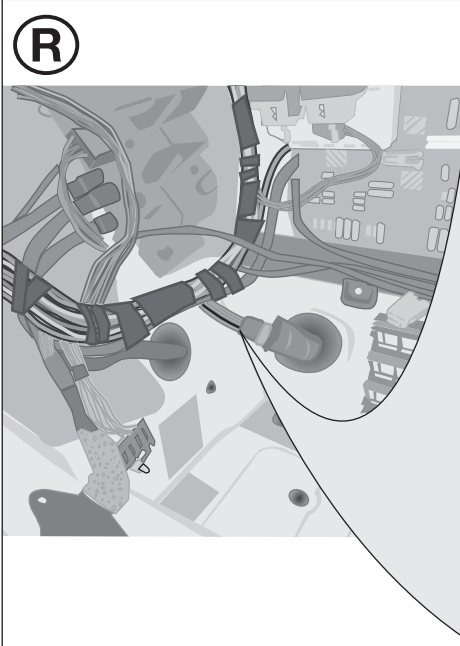

4 series Coupé G22

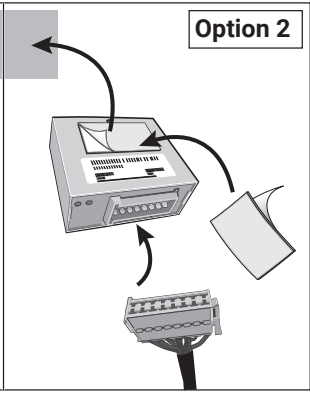
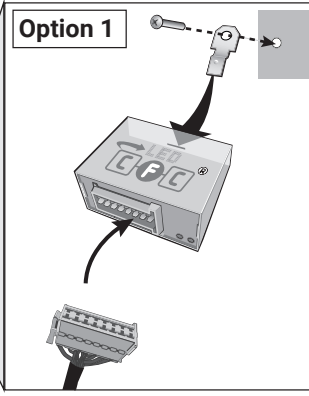
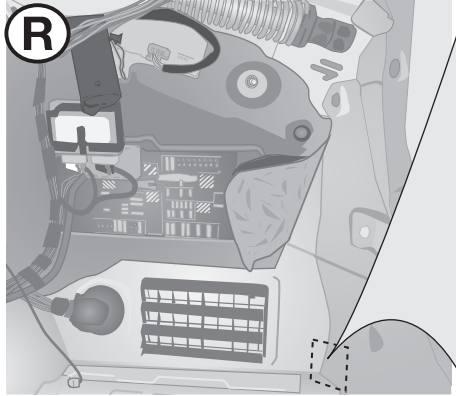

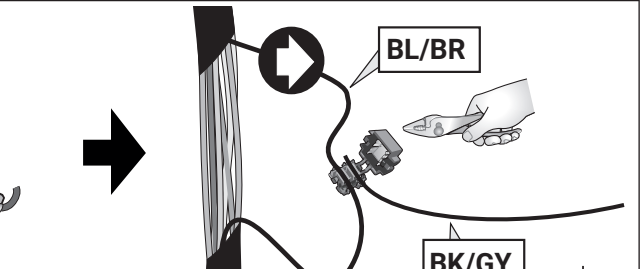
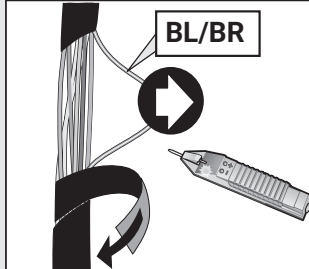
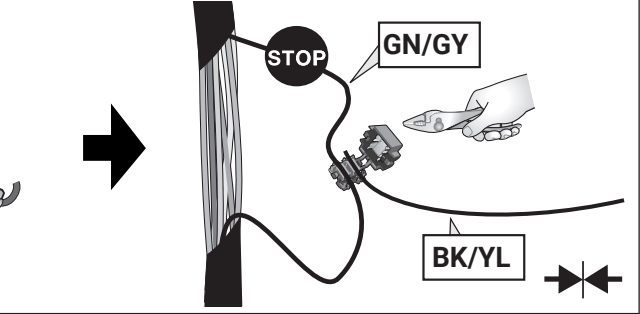
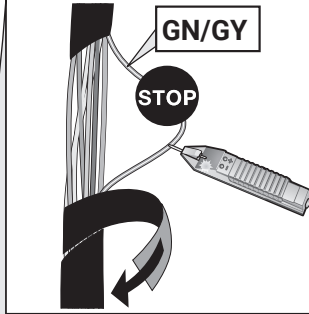

Wichtig!
Unbedingt Hinweise
aus Bild 1 beachten!
Important!
Please note
informations in
picture 1!

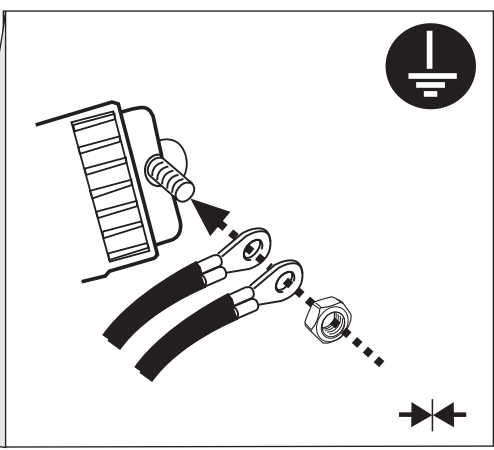
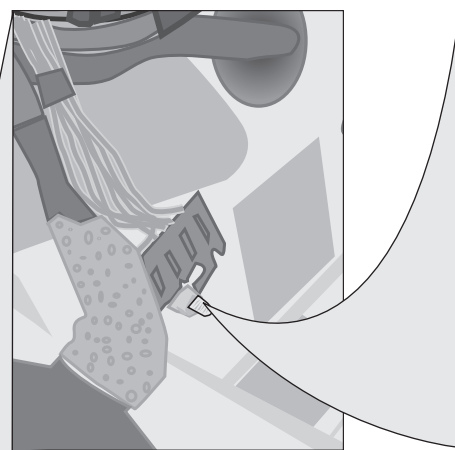
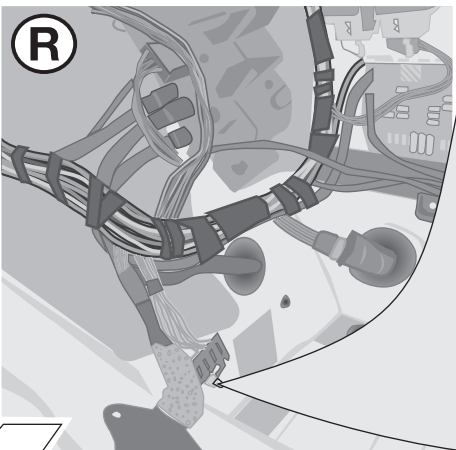
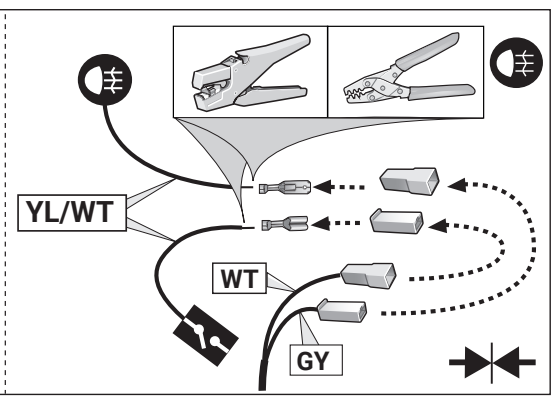
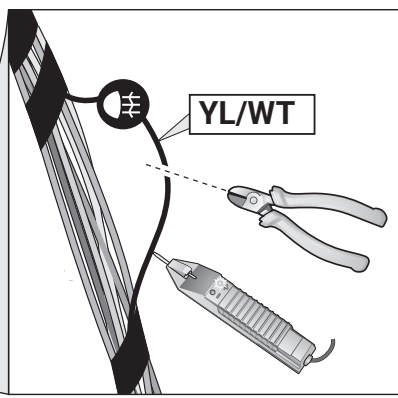
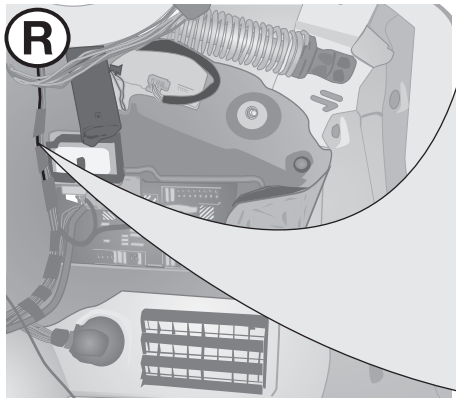

⚠ mehrere BL/BR Kabel!
more than one BL/BR wire!

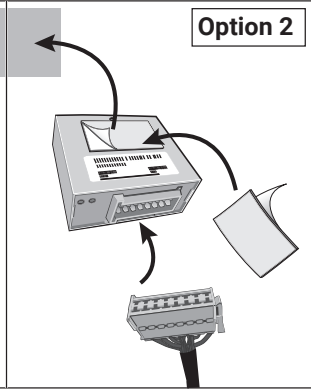
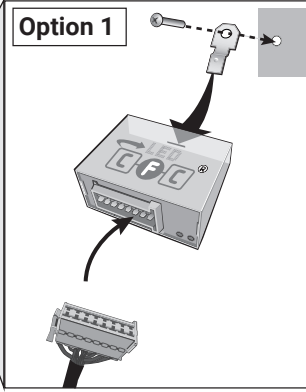
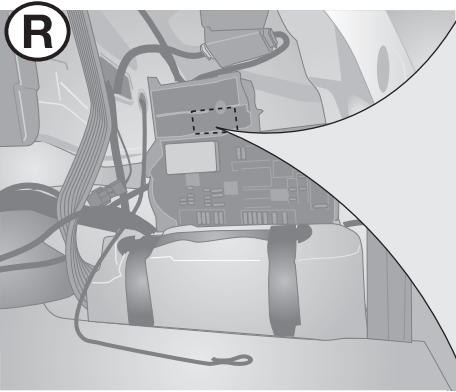



Wichtig!
Unbedingt Hinweise
aus Bild 1 beachten!
Important!
Please note
informations in
picture 1!

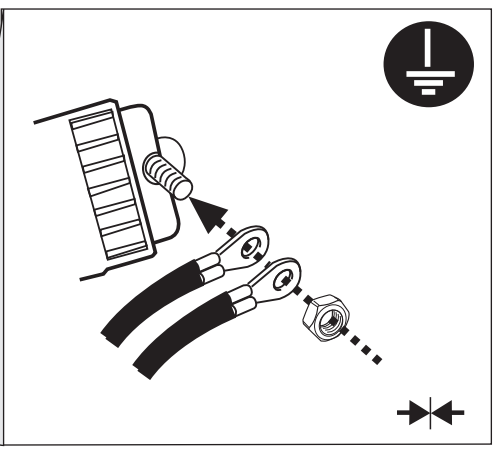
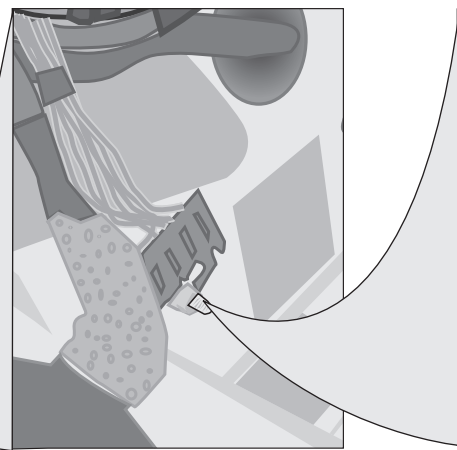
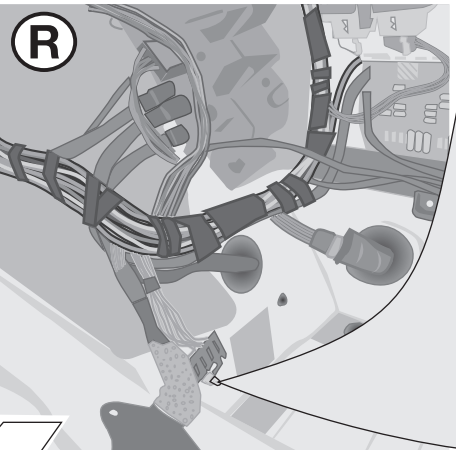
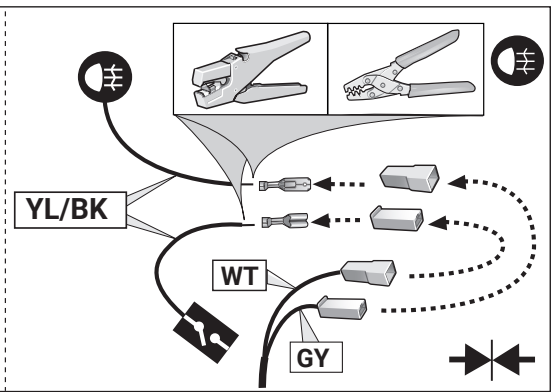
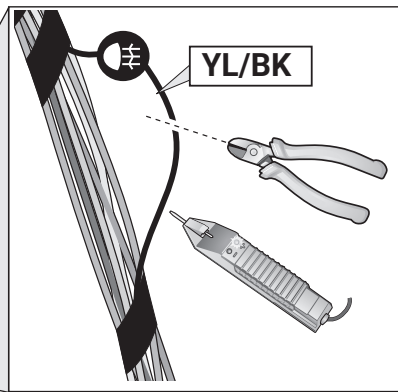
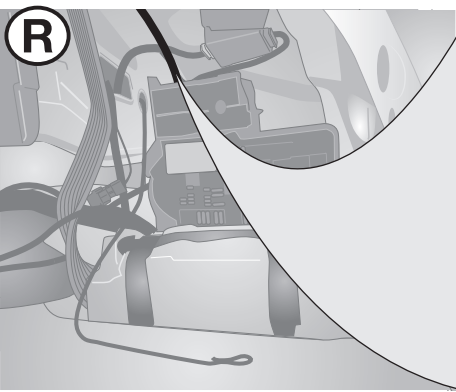
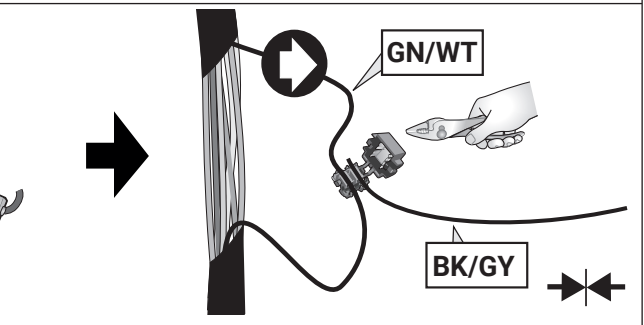
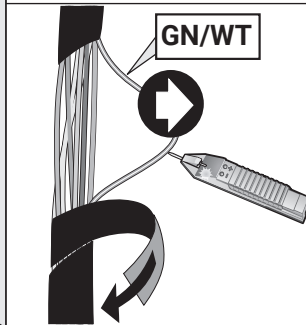
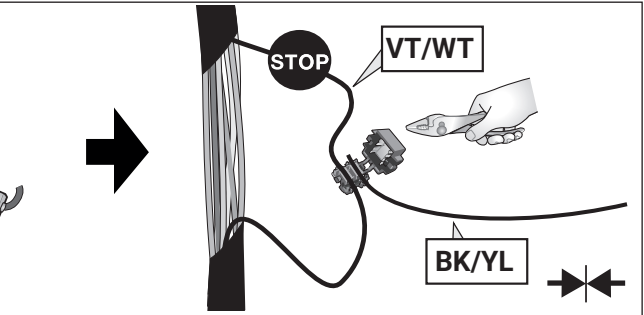
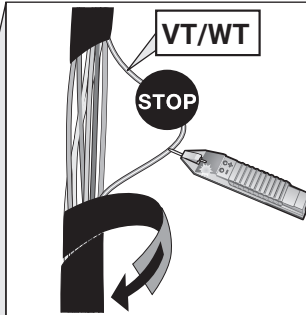
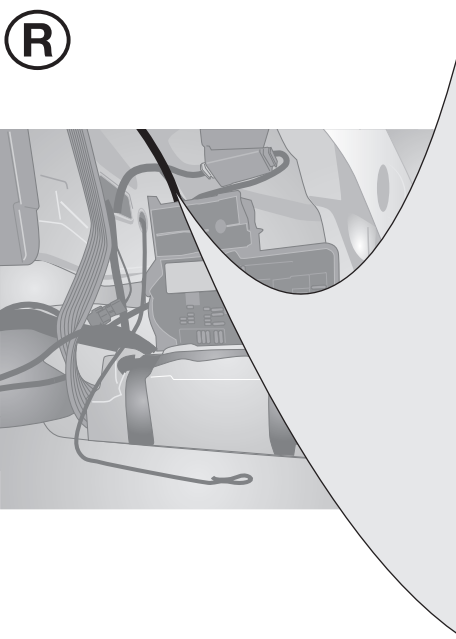

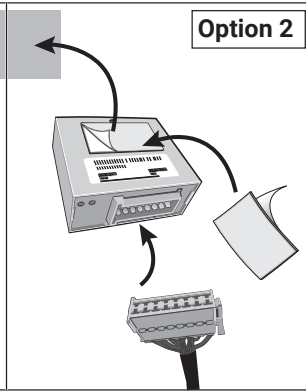
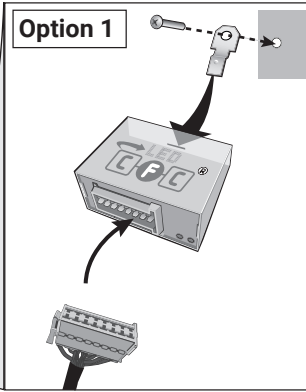
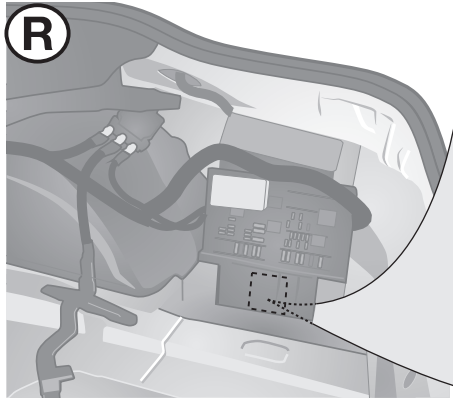

!

Wichtig!
Unbedingt Hinweise
aus Bild 1 beachten!

Important!
Please note
informations in
picture 1!

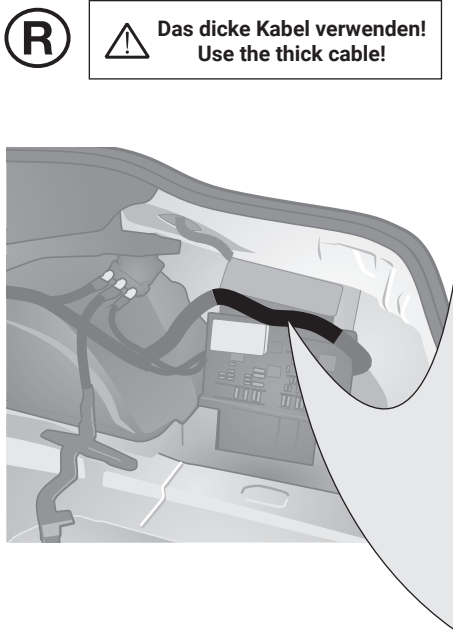

! Das dicke Kabel verwenden!
Use the thick cable!

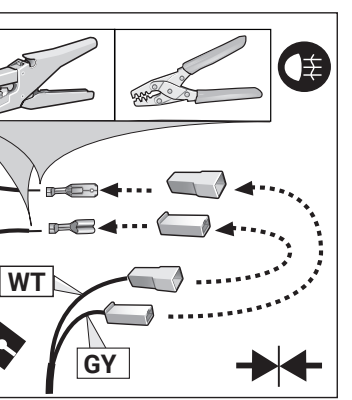
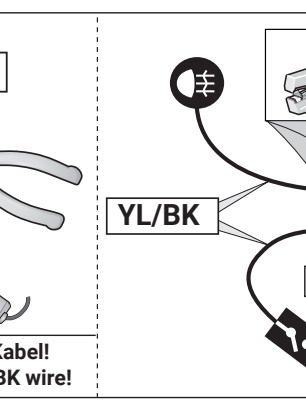
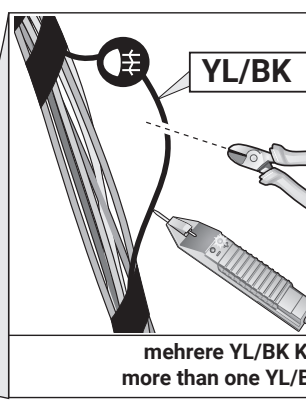
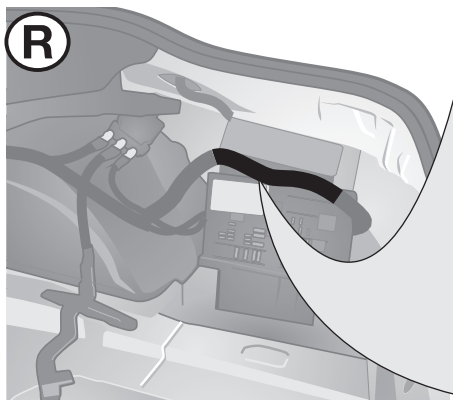
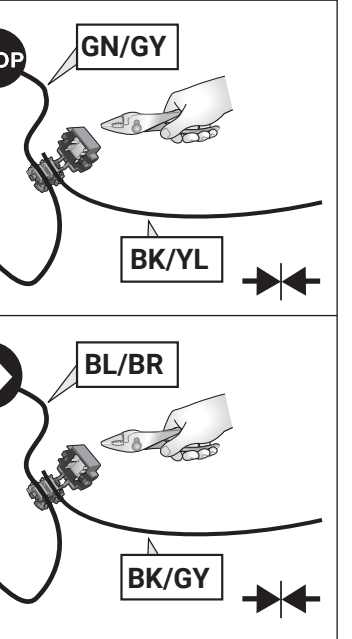
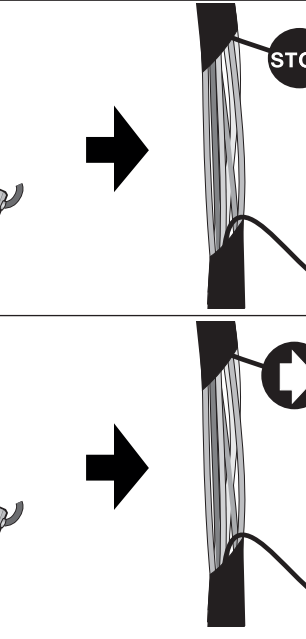
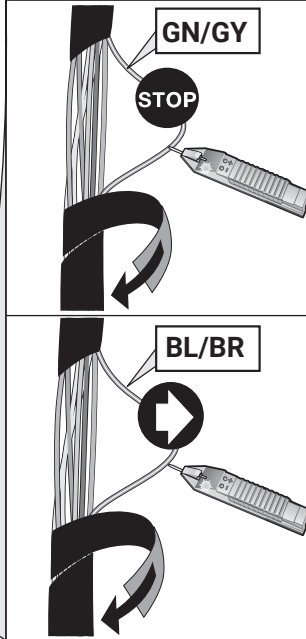

mehrere YL/BK Kabel!
more than one YL/BK wire!

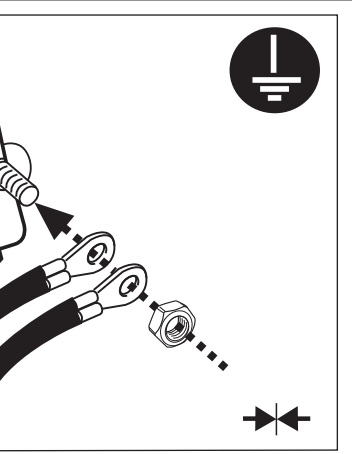
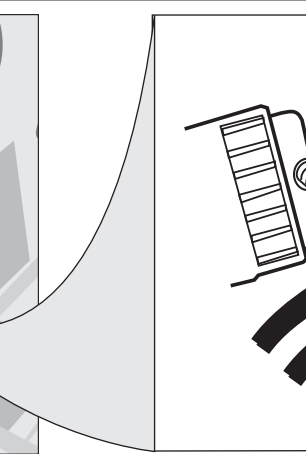
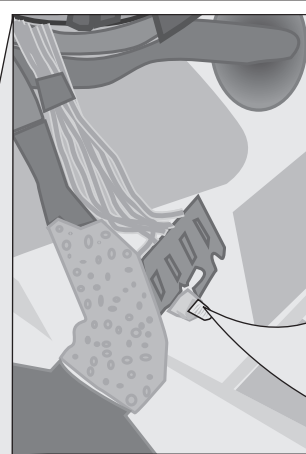
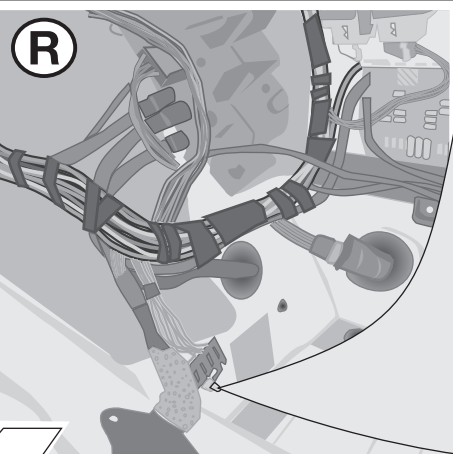

CAN-Data Wire



3er Limousine G20 / 4er Coupé G22

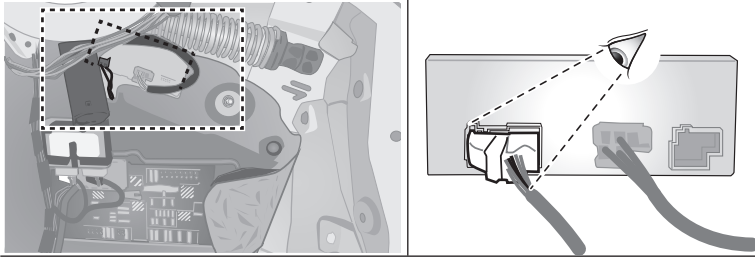

4er Cabrio G23

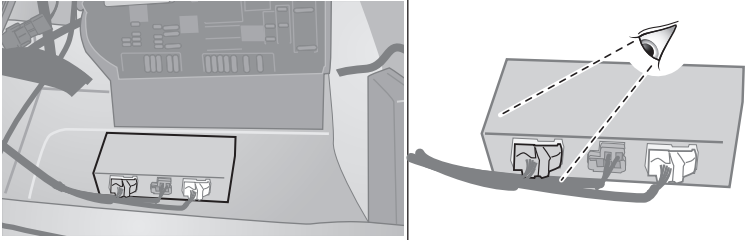

3er Touring G21

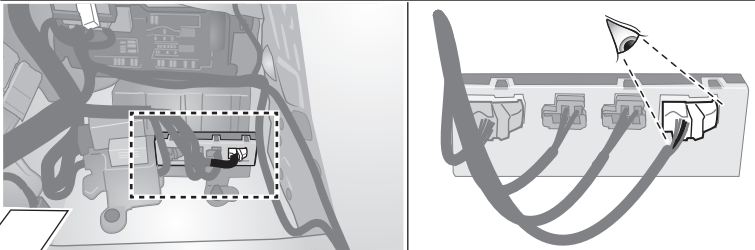

Ja
Yes →

OPTION 1

Z4 G29 →

OPTION 2

Keine
CAN-Datenleitung
im Kofferraum
vorhanden →

OPTION 2

No CAN-data wire
available in boot

20

OPTION 1

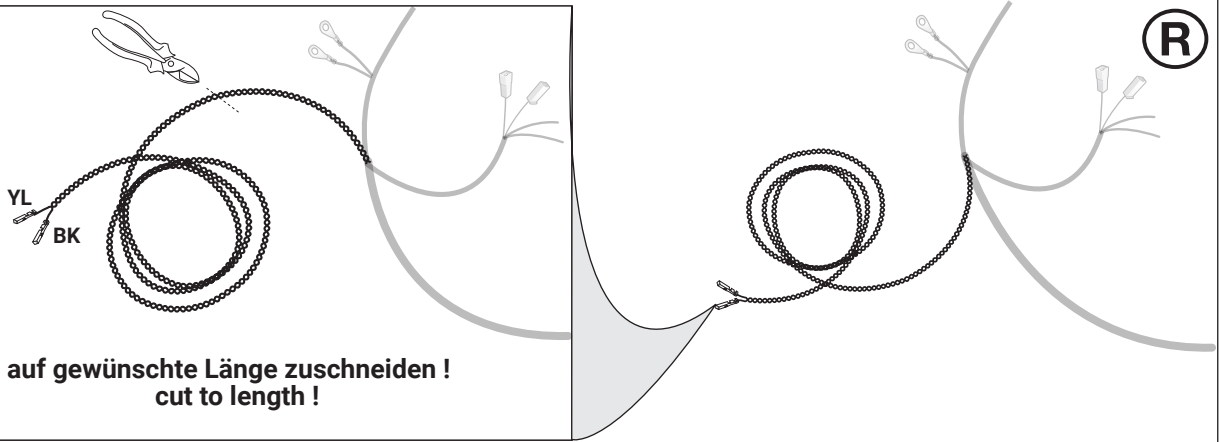

auf gewünschte Länge zuschneiden!
cut to length!

21

OPTION 1

CAN-Data Wire

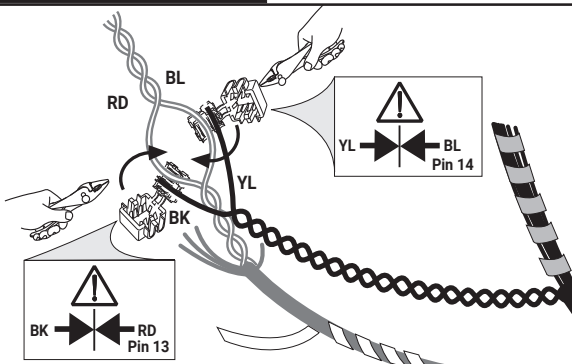

3er Limousine G20
4er Coupé G22

3er Touring G21

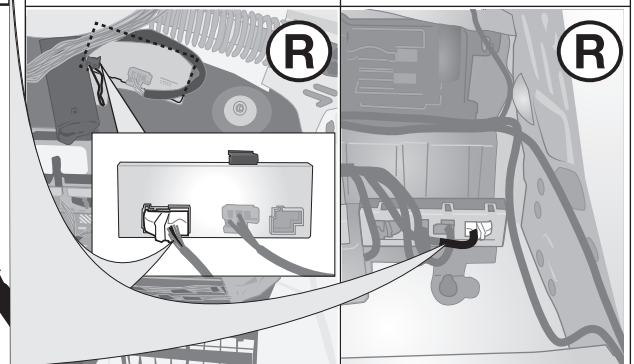

Wichtig!
Unbedingt
Hinweise aus Bild
1 beachten!

Important!
Please note
informations in
picture 1!

22

OPTION 1

4er Cabrio G23



Wichtig!
Unbedingt Hinweise aus Bild 1 beachten!

Important!
Please note informations in picture 1!

CAN-Data Wire

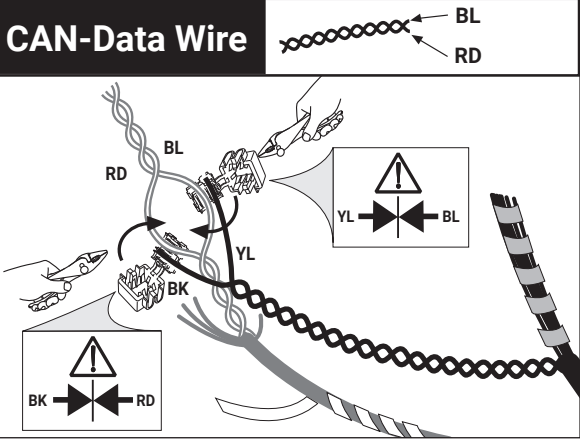

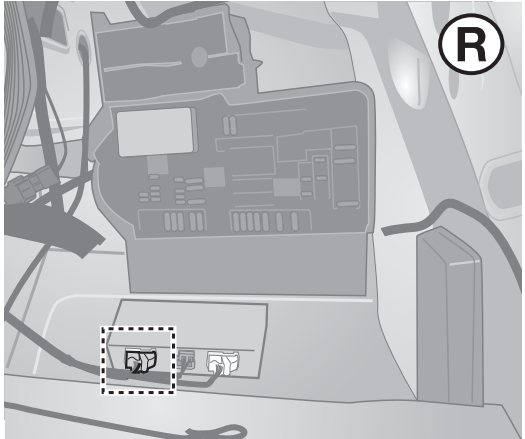

23

OPTION 2

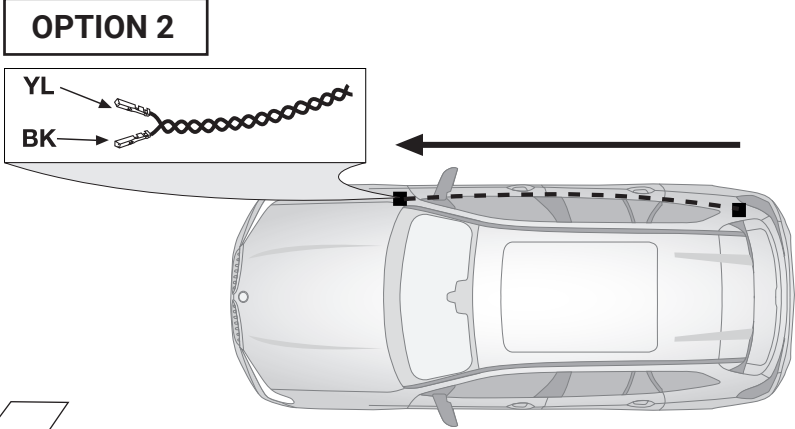

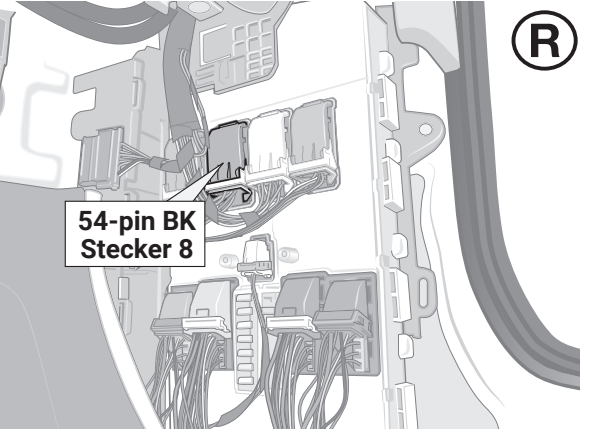

24

OPTION 2

a

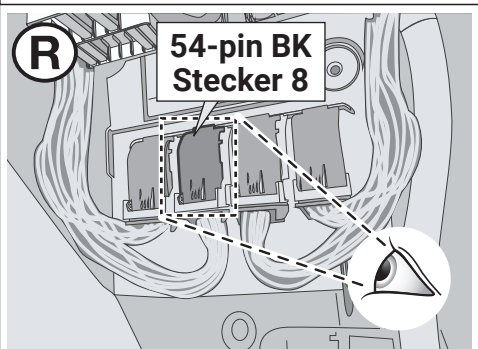
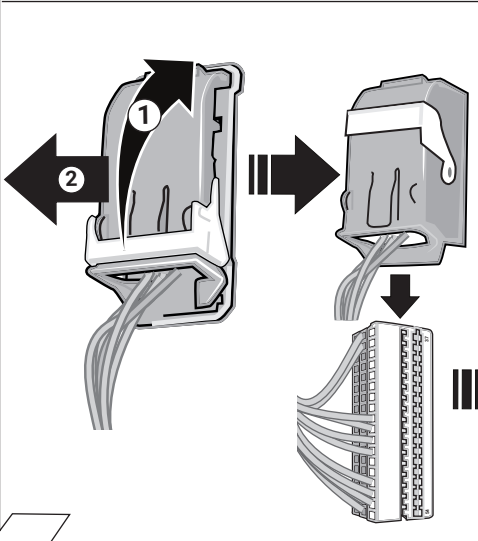

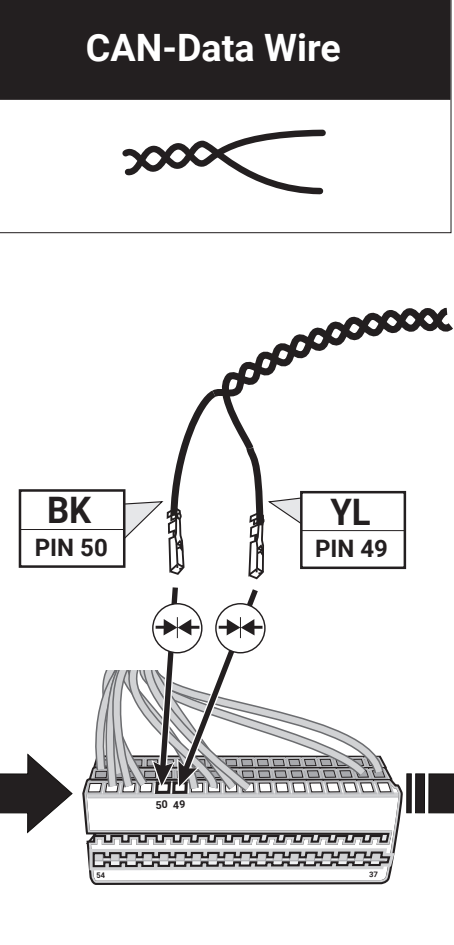

CAN-Data Wire



Wichtig!
Unbedingt Hinweise aus Bild 1 beachten!

Important!
Please note informations in picture 1!



25

OPTION 2

b

CAN-Data Wire

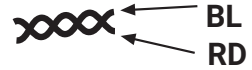

Wichtig!
Unbedingt Hinweise aus Bild 1 beachten!

Important!
Please note informations in picture 1!

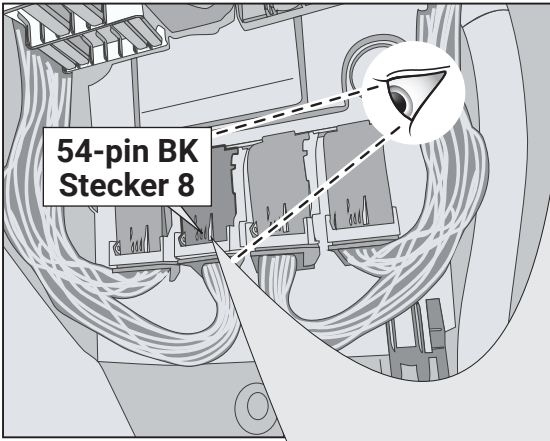

54-pin BK Stecker 8

Achtung: Mehrere CAN Bus Leitungen vorhanden!
Die dünneren Leitungen verwenden!

Attention: more then one CAN Bus wires available!
Use the thinner wires!

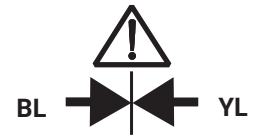
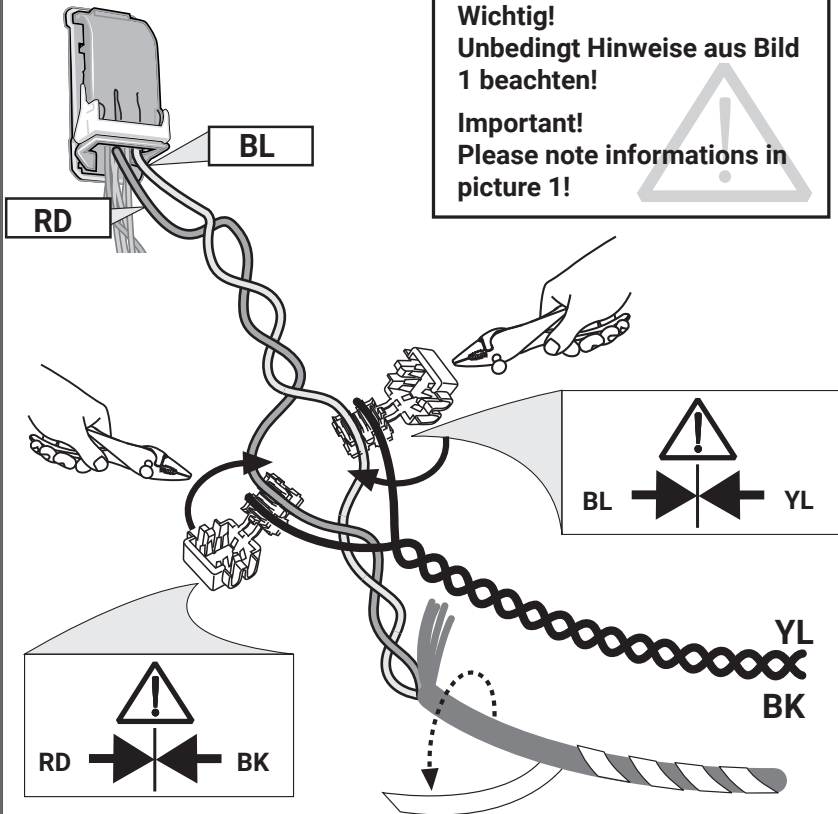

26

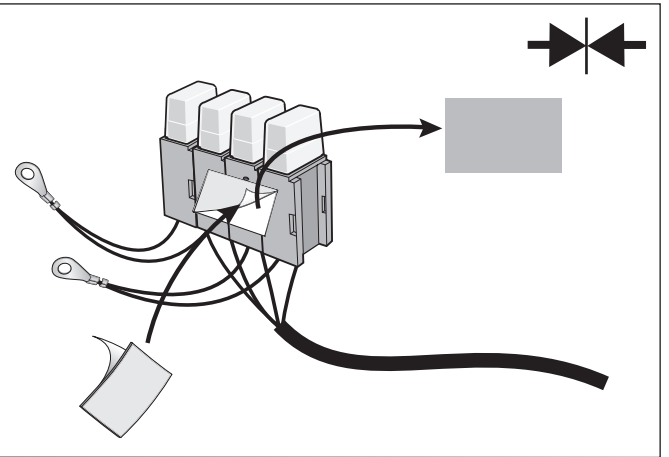
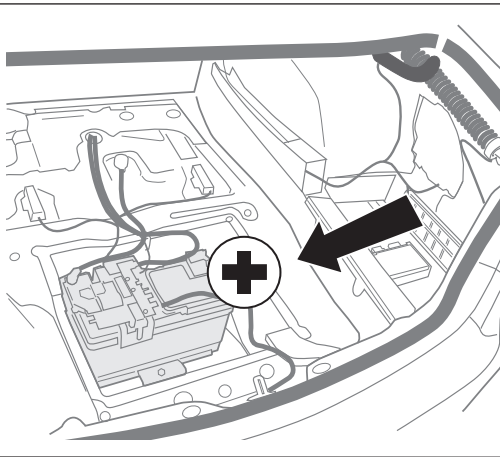
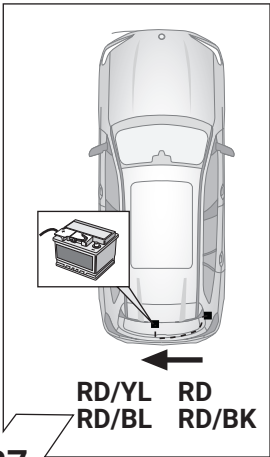

27

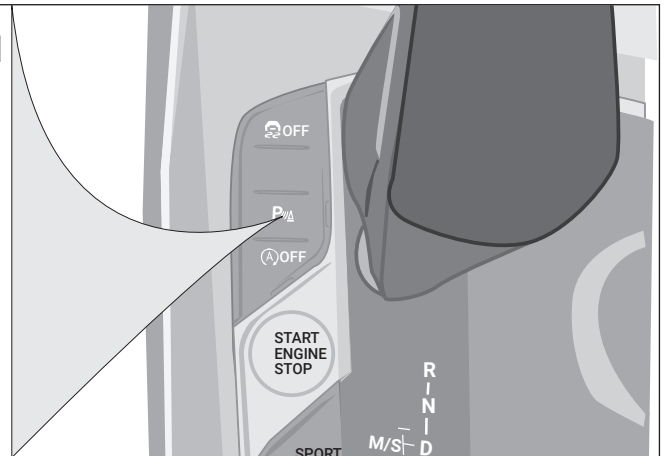
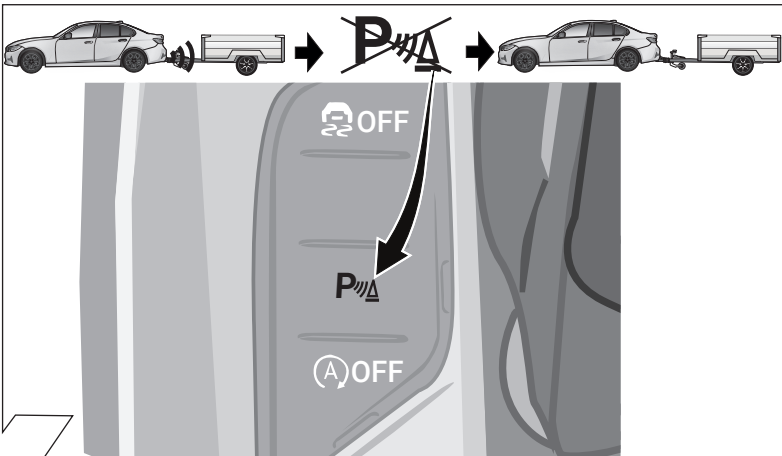

28

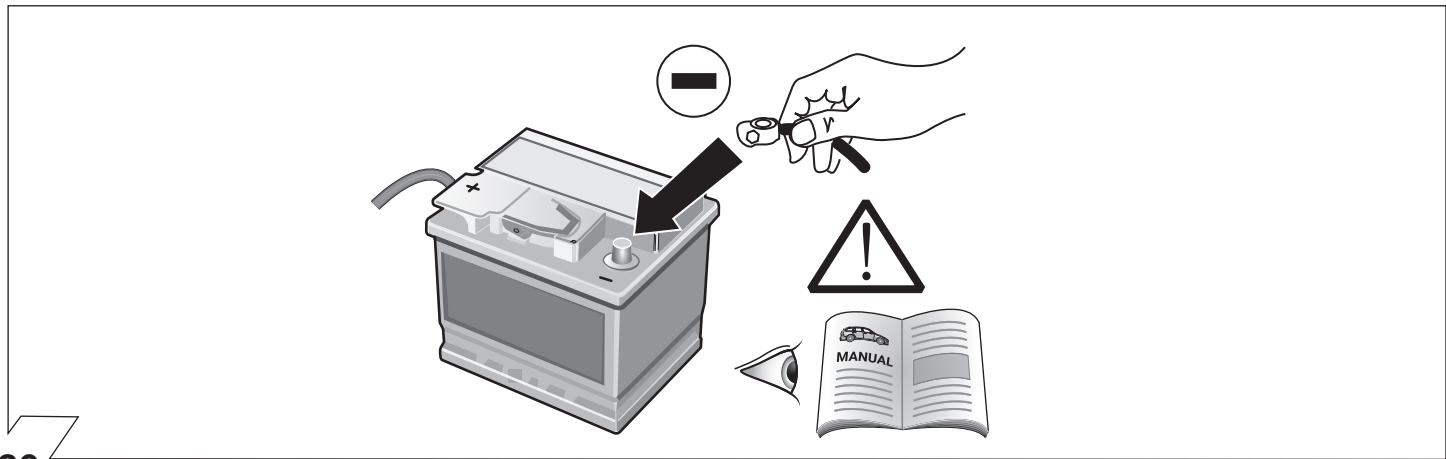

29

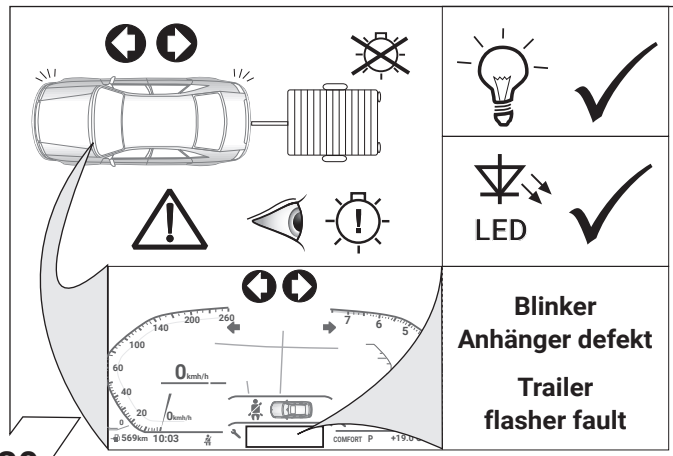

30

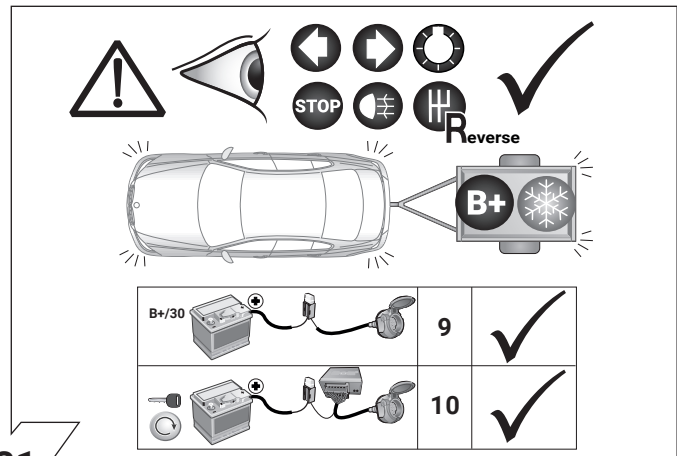

31

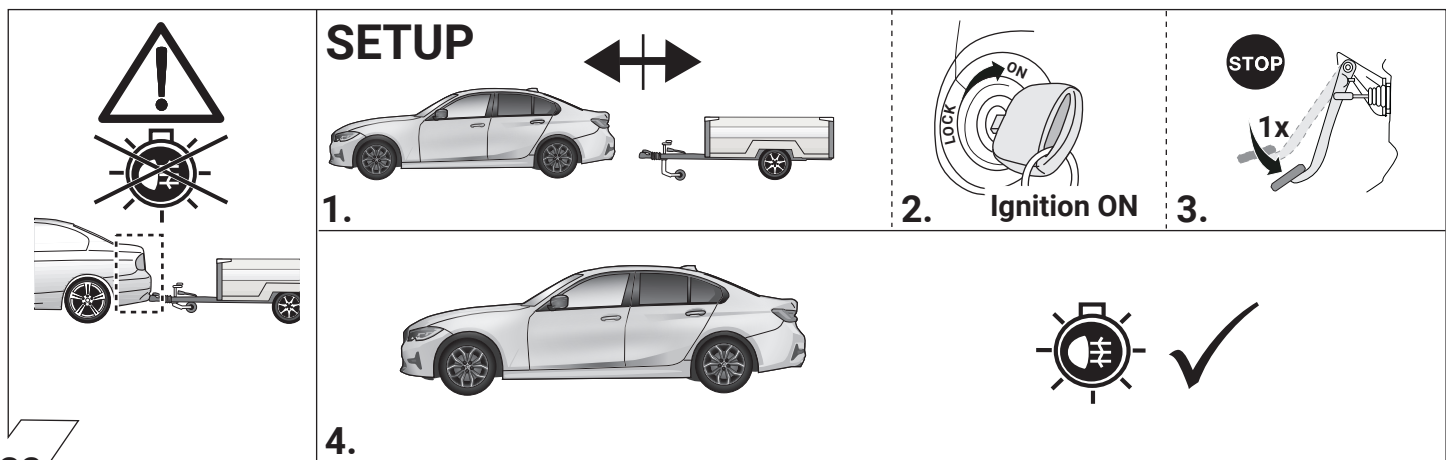

32

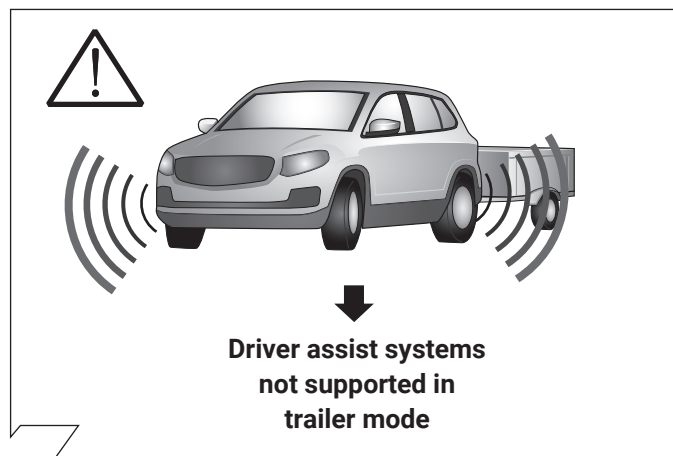

33



34

Optional: Adapter socket 62400003

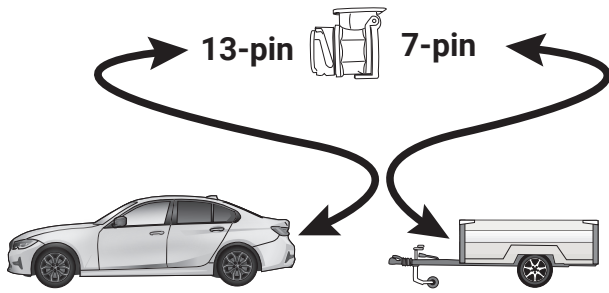



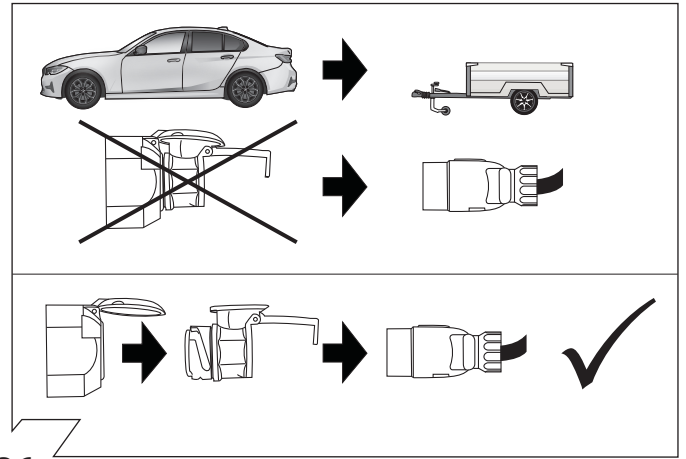



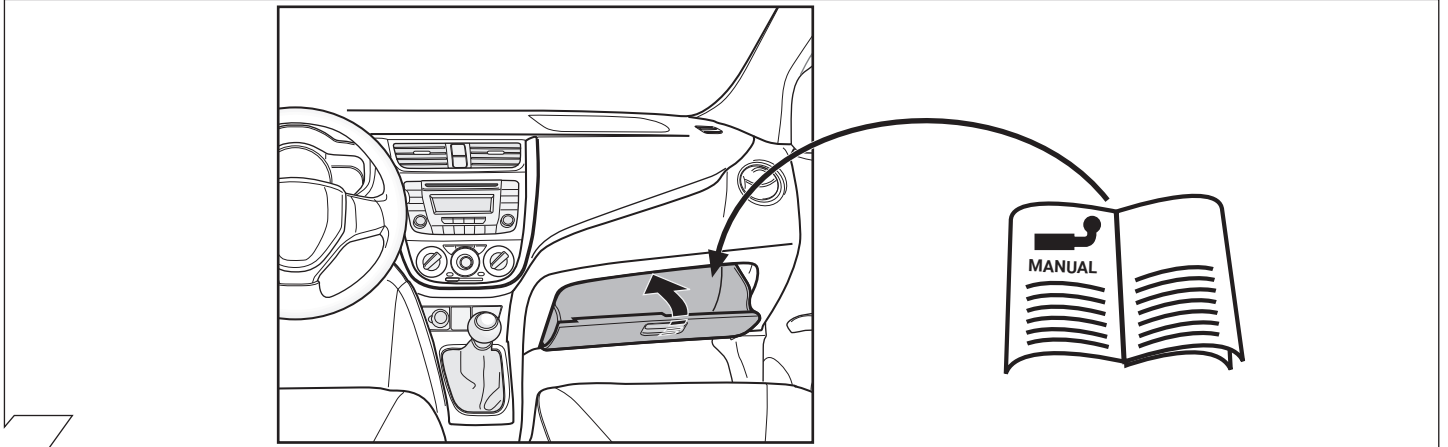



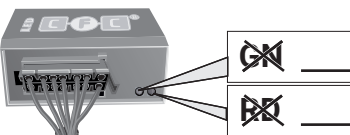







35

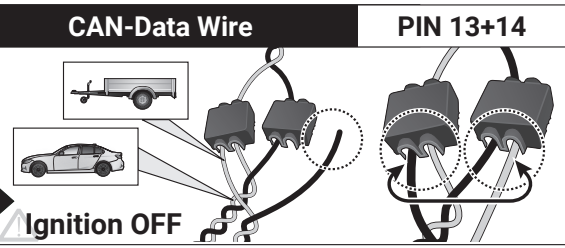
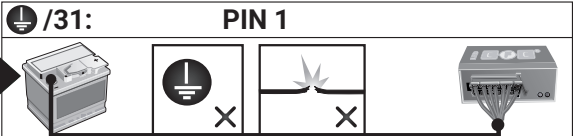

36

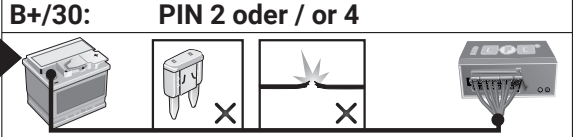

37

D Diagnosefunktion der Kontroll-LED's	GB Diagnosis function of control LEDs	F Fonction diagnostic des LED de contrôle
I Funzione di diagnostica dei LED di controllo	E Función de diagnóstico de los LEDs de control	NL Diagnosefunctie van de controle-LED's
 <p>Ignition OFF</p>	 <p>No CAN-Data =  Standby / Sleepmode</p>	
 <p>Ignition ON</p>	 <p>GN</p> 	
 <p>Ignition ON</p>	 <p>GN</p> 	
 <p>Ignition ON</p>	 <p>RD 1x max 60 sec.</p> <p>3.</p> <p>CAN-Data Wire PIN 13+14</p>  <p>Ignition OFF</p> <p>oder / or</p> <p>/31: PIN 1</p> 	 
 <p>Ignition ON</p>	 <p>RD</p> <p>B+/30: PIN 2 oder / or 4</p> 	
<p>D Blinküberwachung und Leuchten-Substitution bei Ausfall der Anhänger-Blinkleuchten</p> <p>Der Ausfall von einer oder von beiden Anhänger-Blinkleuchten wird je nach Fahrzeugtyp und Ausführung des verbauten Elektro-Einbausatzes wie folgt angezeigt:</p> <ul style="list-style-type: none"> • Erhöhung / Verdoppelung der Blinkfrequenz • Volltextmeldung im Display / Kombi-Instrument • Aktivierung Kontrollleuchte für Lampenausfall • Akustische Warnung via Buzzer oder Voice-Message <p>Bei einem Blinkleuchten-Ausfall ersetzt die gleichseitige Rückleuchte durch Aufleuchten in der Blinkfrequenz eine defekte Anhänger-Blinkleuchte (Leuchten-Substitution!).</p>	<p>GB Indicator failure detection and lamp substitution if the trailer indicators fail</p> <p>The failure of a single or on both trailer indicators will be shown depending on the type of vehicle and electric kit installed as follows:</p> <ul style="list-style-type: none"> • Increase in the flashing frequency • Text message in the Display / combi-instrument • Activated control lamp for light failure • Audible warning via Buzzer or Voice-Message <p>If an indicator fails the left or right rear light compensates the faulty indicator by flashing at the correct frequency! (Lamp substitution).</p>	
<p>F Surveillance des clignotants et substitution des feux en cas de panne des clignotants de la remorque</p> <p>La panne d'un ou des deux clignotants de la remorque est indiquée de la façon suivante en fonction du type de véhicule et du modèle de module électrique monté:</p> <ul style="list-style-type: none"> • Augmentation / doublement de la fréquence de clignotement • Message complet sur l'affichage / l'instrument combiné • Activation du voyant de contrôle pour panne de lampe • Avertissement sonore via buzzer ou message vocal <p>En cas de panne du clignotant, le feu arrière du côté de la panne remplace un clignotant de remorque défectueux en s'allumant à la même fréquence que le clignotant (Substitution des feux!).</p>	<p>I Controllo delle frecce e sostituzione delle lampade in caso di guasto alle frecce del rimorchio</p> <p>A seconda del tipo di veicolo e della versione del kit elettrico montato, il guasto di una o di entrambe le frecce del rimorchio si manifesta come segue:</p> <ul style="list-style-type: none"> • Aumento/raddoppio della frequenza di lampeggiamento • Full text display / strumento combinato • Attivazione della spia di controllo per il guasto lampada • Segnalazione acustica mediante cicalino o messaggio vocale <p>In caso di guasto alla luce della freccia, la luce posteriore dello stesso lato si accende sostituendo nella frequenza del lampeggio la freccia difettosa del rimorchio. (Sostituzione delle lampade!).</p>	
<p>E Control de intermitentes y sustitución de lámparas en caso de fallo de los intermitentes del remolque</p> <p>El fallo de uno o de ambos intermitentes del remolque se indicará de la siguiente manera en función del tipo del vehículo y de la ejecución del juego de montaje eléctrico montado:</p> <ul style="list-style-type: none"> • Aumento/duplicación de la frecuencia de parpadeo • Mensaje de texto completo en el display/instrumento combinado • Activación de la lámpara piloto para el fallo de lámparas • Advertencia acústica mediante zumbador o mensaje de voz <p>Si hay un fallo de intermitente, la luz trasera del mismo lado reemplazará la lámpara defectuosa del intermitente parpadeando en la misma frecuencia que el intermitente (Substitución de lámparas!).</p>	<p>NL Knippercontrole en lampvervanging bij uitval van de knipperlampen van een aanhangwagen</p> <p>De uitval van één of beide knipperlampen van een aanhangwagen wordt afhankelijk van het voertuigtype en de uitvoering van de ingebouwde elektroset als volgt aangegeven:</p> <ul style="list-style-type: none"> • Verhoging / verdubbeling van de knipperfrequentie • Volledige tekstweergave op het display / combi-instrument • Activering controlelampje voor uitval van een lamp • Akoestische waarschuwing via buzzer of Voice-Message <p>Bij een uitval van (een) knipperlamp(en) vervangt het gelijkzijdige achterlicht door aan te flitsen bij de knipperfrequentie een defecte knipperlamp van een aanhangwagen (Lampvervanging!).</p>	

ERKLÄRUNG SYMBOLE	SYMBOL EXPLANATION	EXPLICATION DES SYMBOLES	SPIEGAZIONE DEI SIMBOLI	EXPLICACIÓN DE LOS SIMBOLES	VERKLARING SYMBOLEN
(D)	(GB)	(F)	(I)	(E)	(NL)
	linke (58-L) bzw. rechte (58-R) Schlussleuchte	feu arrière gauche (58-L) respectivement droite (58-R)	luce posteriore sinistra (58-L) rispettivamente destra (58-R)	pilato trasero izquierdo (58-L) respectivamente derecho (58-R)	Linker (58-L) c.q. rechter (58-R) achterlicht
	Bremsleuchte (54) / 3. Bremsleuchte (54)	feu de stop (54) / 3ième feu de stop (54)	luce d'arresto (54) / 3. luce d'arresto (54)	tercera luz de freno (54)	Remlicht (54) / 3e remlicht (54)
	Fahrtrichtungsanzeiger links	feu indicateur de direction gauche	indicatore di direzione sinistra	luz indicadora de dirección de marcha izquierda	Richtingaanwijzer links
	Fahrtrichtungsanzeiger rechts	feu indicateur de direction droite	indicatore di direzione destra	luz indicadora de dirección de marcha derecha	Richtingaanwijzer rechts
	Nebelschlussleuchte(n)	feu (x) arrière (s) de brouillard	fendinebbia	luz (-ces) trasera (s) antinebla (s)	Mistachterlicht(en)
	Rückfahrleuchte(n)	feu (x) de marche arrière	luce (i) retromarcia	luz (-ces) de marcha atrás	Achterruitrijlicht(en)
	Dauerstrom / Steckdose 13P Kammer 9	courant continue / prise de courant à 13 pôles, compartiment 9	alimentazione continua / presa 13 poli, camera 9	positivo continuo / caja de anclufe a 13 polos, cámara 9	Continuustroom / stekker doos 13P kamer 9
	Ladeleitung / Steckdose 13P Kammer 10	cable de charge / prise de courant à 13 pôles, compartiment 10	cavo di carica / presa 13 poli, camera 10	cable de carga / caja de anclufe a 13 polos, cámara 10	Laadraad / stekkerdoos 13P kamer 10
	Anhänger / permanente Stromversorgung	détection de la fonction "remorque" courant continue / alimentation électrique permanente	rimorchio / riconoscimento rimorchio corrente / alimentazione continua	remolque / detección del remolque positivo continuo / alimentación de corriente permanente	Aanhanger / aanhangeridentificatie Continuustroom / permanente stroomvoorziening
	Masse (31)	masse (31)	massa (31)	masa (31)	Massa (31)
	Batteriepolklemme Anschluss Minus	borne "moins" de la batterie	connessione negativa della batteria	conexión negativa de batería	Accuopolklem aansluiting min
	Batteriepolklemme Anschluss Plus	borne "plus" de la batterie	connessione positiva della batteria	conexión positiva de batería	Accuopolklem aansluiting plus
	Sicherung / Sicherungsstärke 20 Ampère	fusible / ampères	fusibile / fusibile con capacity 20 Ampère	fusible / amperaje 20 amperes	Zekering / zekeringsterkte 20 Ampère
	Zigarettenanzünder / Zubehör -Steckdose	allume-cigare / prise d'accessoires	accendisigari / presa accessori	encendedor de cigarrillos / caja de accesorios	Sigarettenaanstekker / accessoires stekkerdoos
	Lautsprecher / Warnsummer	haut-parleur / vibreur	autoparlante / cicalino	altavoz / señal acustica de advertencia	Luidspreker / waarschuwingszoemer
	Einparkhilfe	assistance au parking	sensori di parcheggio	ayuda para aparcar	Inparkeerhulp
	Schalter / Funktionsursprung	interrupteur / origine de fonction	interruttore / origine funzione	interruptor / origen de función	Schakelaar / functieoorsprong
	verbinden	raccorder	connessione	conectar	Koppelen
	trennen	séparer	sconnessione	separar	Ontkoppelen
	beachten / siehe weitere Informationen	considérer / voir informations ultérieures	considerare / vedere ulteriori informazioni	considerar / véase las informaciones	Let op / bekijk verdere informatie
	beachte ausgewählten Bereich	faire attention à la zone sélectionnée	considerare area selezionata	considerar el área seleccionada	Let op gekozen bereik
	vorhanden / belegt / i.O.	disponible / occupé / OK	presente / occupato / OK	presente / ocupado / OK	Aanwezig / bezet / i.o.
	nicht vorhanden / nicht belegt / nicht i.O.	pas disponible / pas occupé / pas OK	non presente / non occupato / non OK	non presente / non occupado / non OK	Niet aanwezig / niet bezet / niet i.o.
	links	gauche	sinistra	izquierdo	Links
	rechts	droite	destra	derecho	Rechts
	Akustische Signalisierung	signalisation acoustique	segnalazione acustica	señalación acústica	Akoestische signalering
	Achtung / wichtiger Hinweis	attention / indication importante	attenzione / indicazione importante	atención / indicación importante	Attentie / belangrijke instructie