

## Toyota Avensis Sedan & Wagon 11/2008-

Partnr.: TO-148-BB

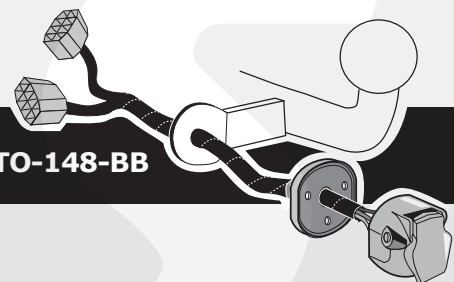

|           |   |           |  |
|-----------|---|-----------|--|
| <b>DE</b> | <b>Einbauanleitung Elektrosatz Anhängervorrichtung mit 12-N Steckdose It. DIN/ISO Norm 1724.</b>                                  | <b>CZ</b> | <b>Montážní pokyny: souprava pro elektrické propojení tažné tyče s 12 - N zásuvkou do normy DIN/ISO 1724.</b>            |
| <b>FR</b> | <b>Instructions de montage du faisceau électrique pour crochet d'attelage conforme à la norme DIN/ISO 1724 prise 12-N</b>         | <b>DK</b> | <b>Monteringsvejledninger for det elektriske ledningsføringssæt for trækstang med 12-N stikdåse, DIN/ISO, norm 1724.</b> |
| <b>NL</b> | <b>Montage-handleiding elektrokabelset voor trekhaak met 12-N contactdoos vlg. DIN/ISO norm 1724.</b>                             | <b>FI</b> | <b>Ohjeet vetokoukun sähkökaapelisarjan asentamiseen, jossa on DIN/ISO 1724 mukainen 12-N liitin.</b>                    |
| <b>GB</b> | <b>Fitting instructions electric wiring kit tow bar with 12-N socket up to DIN/ISO Norm 1724.</b>                                 | <b>GR</b> | <b>Οδηγίες συναρμολόγησης ηλεκτρικού σετ καλωδίων μπάρας ρυμούλκησης με υποδοχή 12-N μέχρι DIN/ISO Κανόνας 1724.</b>     |
| <b>ES</b> | <b>Instrucciones de montaje de kit eléctrico para enganche de remolque con caja de conexiones 12-N según norma DIN/ISO 1724.</b>  | <b>NO</b> | <b>Monteringsanviser elkabelsett for trekrok med 12-N koblingsboks ifølge DIN/ISO norm 1724.</b>                         |
| <b>IT</b> | <b>Istruzioni di montaggio di set di cavi elettrici per gancio da traino con zoccolo a 12 N conforme alla norma DIN/ISO 1724.</b> | <b>PL</b> | <b>Instrukcje montażu zestawu okablowania elektrycznego dyszla holowniczego z 12-N stykowym gniazdem DIN/ISO 1724.</b>   |
| <b>SE</b> | <b>Monteringsanvisningar elkabelsats för dragkrok med 12-N kontaktdosa enligt DIN/ISO norm 1724.</b>                              |           |  |

|           |   |   |
|-----------|---|---|
| <b>DE</b> | - Wir weisen ausdrücklich darauf hin, dass eine unsachgemäße und nicht in einer Fachwerkstatt durchgeführte Montage einen Verzicht auf Entschädigung jeglicher Art insbesondere bezüglich des Produkthaftpflichtrechts zur Folge hat  | - Technische Änderungen vorbehalten.<br>- Widerstand nur gemäß der Tabelle auf dem Anhänger verwenden.  |
| <b>FR</b> | - Il est expressément prévu qu' on ne saurait se prévaloir d'un quelconque préjudice contractuel ou rédhibitoire si le montage avait été fait en dépit des dites instructions ou dans un garage ne disposant pas des équipements adéquats.  | - Sous réserve de modifications techniques.<br>- Ne excédez pas la charge maximale.   |
| <b>NL</b> | - Wij wijzen er met nadruk op, dat ondeskundige en niet door een vakkundige werkplaats uitgevoerde montage tot gevolg heeft dat daardoor ieder recht op schadevergoeding, ook op wettelijke aansprakelijkheid inzake producten, vervalt.  | - Technische wijzigingen voorbehouden.<br>- Gebruik alleen belasting volgens aansluittabel op het getrokken voertuig.   |
| <b>GB</b> | - We would expressly point out that assembly not carried out properly by a competent installer will result in cancellation of any right to damage compensation, in particular those arising by virtue of the product liability act.   | - Contents of these kits and their fitting manuals are subject to alteration without notice, please ensure that these instructions are read and fully understood before commencing installation.<br>- Do not overload circuits; the maximum loads per connection are detailed in this manual. |
| <b>ES</b> | - El montaje inapropiado y efectuado por personal no cualificado originará la pérdida de todo derecho a indemnización o la expiración de toda responsabilidad civil con respecto al producto.   | - Nos reservamos el derecho a efectuar modificaciones técnicas.<br>- Utilice sólo cargas de acuerdo a la tabla de conexión del vehículo remolcado.  |
| <b>IT</b> | - Sottolineiamo espressamente che un montaggio inadeguato ed eseguito da un'officina non specializzata ha come conseguenza il decadere di qualsiasi diritto al risarcimento danni, nonché alla responsabilità legale relativa ai prodotti.  | - Ci si riserva il diritto di apportare modifiche tecniche.<br>- Utilizzare esclusivamente un carico conforme alla tabella degli allacci relativa al veicolo in questione.  |
| <b>SE</b> | - Vi påpekar med eftertryck att all rätt till skadeersättning och all laglig ansvarighet förfaller om monteringen inte har utförts på rätt sätt och av en professionell verkstad.   | - Tekniska ändringar förbehålles.<br>- Använd endast belastning enligt anslutningstabellen på det dragna fordonet.  |
| <b>CZ</b> | - Výslovně zdůrazňujeme, že jakákoli montáž, která není provedená ve specializované dílně, má za následek odvolání nároků na kompenzaci jakéhokoliv druhu, obzvláště vyplývajících ze zákona o odpovědnosti za způsobené škody.   | - Změny mohou být provedeny bez oznámení.<br>- Používejte pouze při maximálním nabití podle tabulky na tažném vozidle.  |
| <b>DK</b> | - Vi ønsker at gøre udtrykkeligt opmærksom på at forkert samling, der ikke er udført af et specialiseret værksted, resulterer i bortfaldelse af kompenseringskrav af alle slags, i særdeles krav der måtte opstå omkring det lovpligtige ansvar.                                      | - Kan ændres uden varsel.<br>- Brug kun den maksimale belastning, i overensstemmelse med forbindelsestabellen for bugserede køretøjer.  |
| <b>FI</b> | - Korostamme, että kaikki oikeudet vahinkokorvaukseen kuten myös valmistajan laillinen vastuu raukeavatt, mikäli asennusta ei ole toteutettu oikealla tavalla eikä ammattitaitoisen asiantuntijan toimesta.   | - Oikeus teknisiin muutoksiin ilman erillistä huomautusta pidätetään.<br>- Kuormita työvirtapiiriä ainoastaan hinattavan ajoneuvon kytkentäkaavion mukaisesti.  |
| <b>GR</b> | - Επισημαίνουμε κατηγορηματικά ότι οποιαδήποτε εσφαλμένη συναρμολόγηση, η οποία δεν έχει πραγματοποιηθεί ειδικό εργαστήριο θα οδηγήσει σε απονομή των αξιώσεων επιβολής αποζημιώσεων οποιαδήποτε είδους, ειδικά όσα προκύπτουν από το νόμο ευθύνης προϊόντων.                         | - Μπορεί να τροποποιηθεί χωρίς προηγούμενη ειδοποίηση.<br>- Χρησιμοποιείτε μόνο μέγιστο ηλεκτρικό φορτίο σύμφωνα με τον πίνακα σύνδεσης στο ρυμούλκούμενο όχημα.  |
| <b>NO</b> | - Vi påpeker ettertrykkelig at all rett til skadeerstatning og rettslig ansvar forfaller dersom monteringen ikke er blitt utført på riktig måte og av et profesjonelt verksted.   | - Tekniske endringer forbeholdes. - Overskrid ikke grensene anvist i tilkoblingstabellen på tilhengeren eller det tilkoblede kjøretøyet.  |
| <b>PL</b> | - Chcielibyśmy wyraźnie zaznaczyć, iż wszelki nieprawidłowy montaż, który nie jest wykonywany w specjalistycznym warsztacie pociąga za sobą utratę możliwości dochodzenia wszelkiego typu roszczeń, w szczególności tych wynikających z odpowiedzialności producenta za swój produkt. | - Podlega zmianom bez powiadomienia.<br>- Używać tylko takiego maksymalnego obciążenia które wynika z tabliczki połączeń holowanego pojazdu.  |

Einzelteilliste

Liste de pieces

Onderdelenlijst

Part list

Lista de componentes

Elenco componenti

Dellista

Seznam dílů

Del-liste

Osaluettelo

Κατάλογος εξαρτημάτων

Delliste

Lista części

DE

FR

NL

GB

ES

IT

SE

CZ

DK

FI

GR

NO

PL

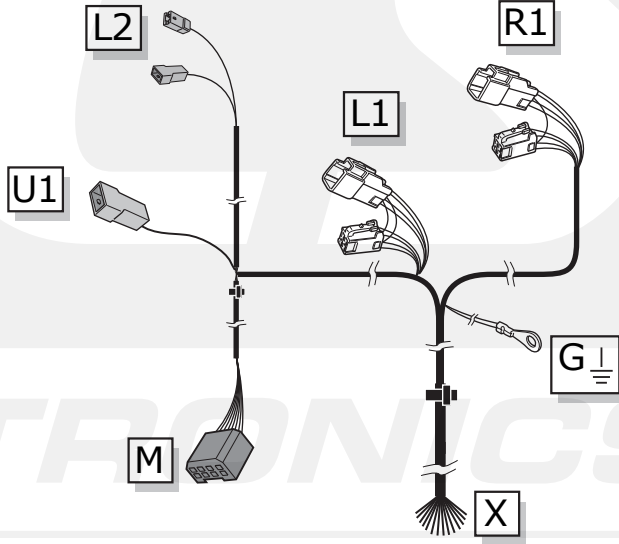

U1

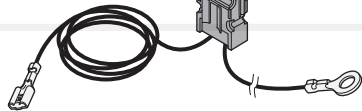

U3

U2



M

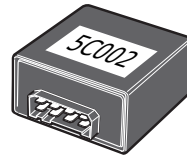

M

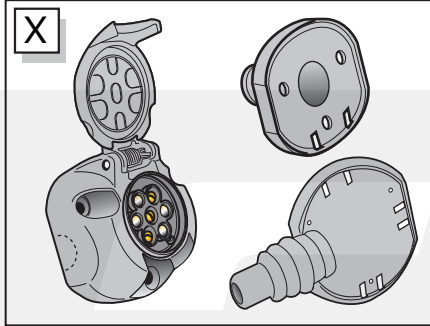
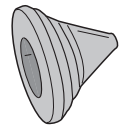

X



1x

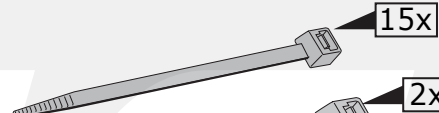

15x



2x

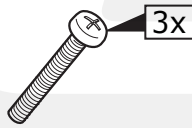

3x



3x

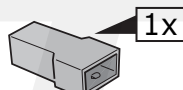

1x

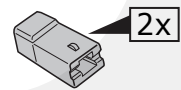

2x

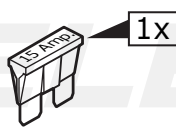

1x



1x

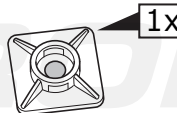

1x



1x



1x

SEDAN

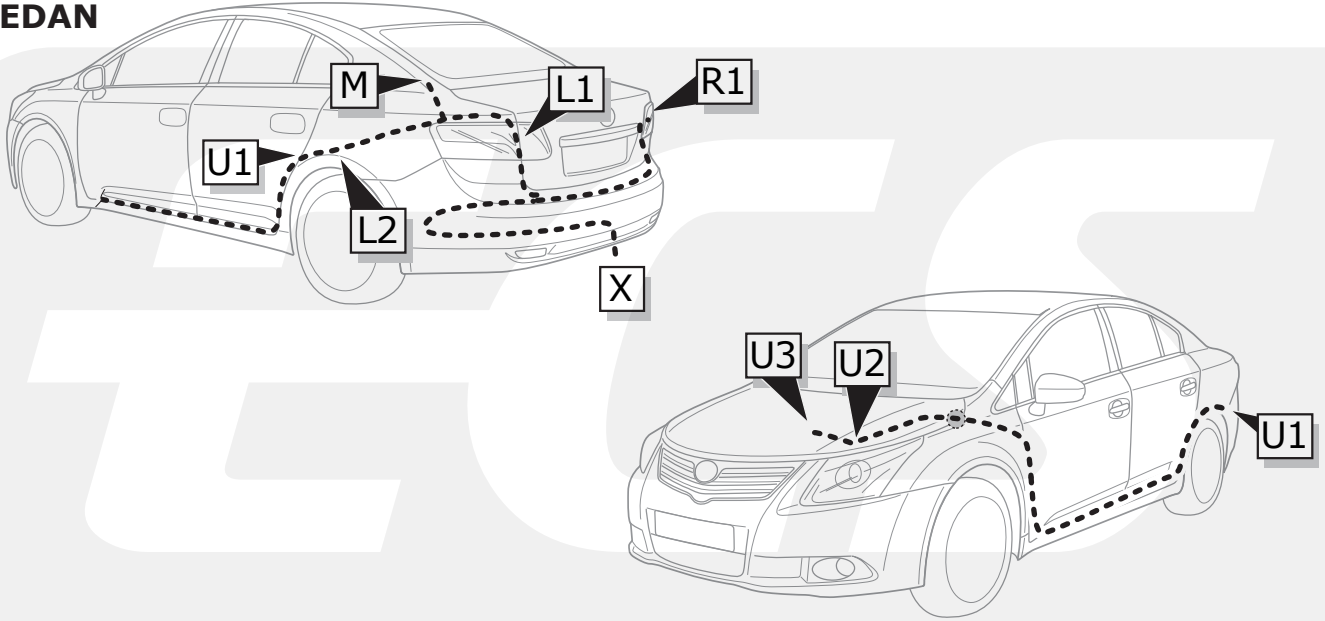

WAGON

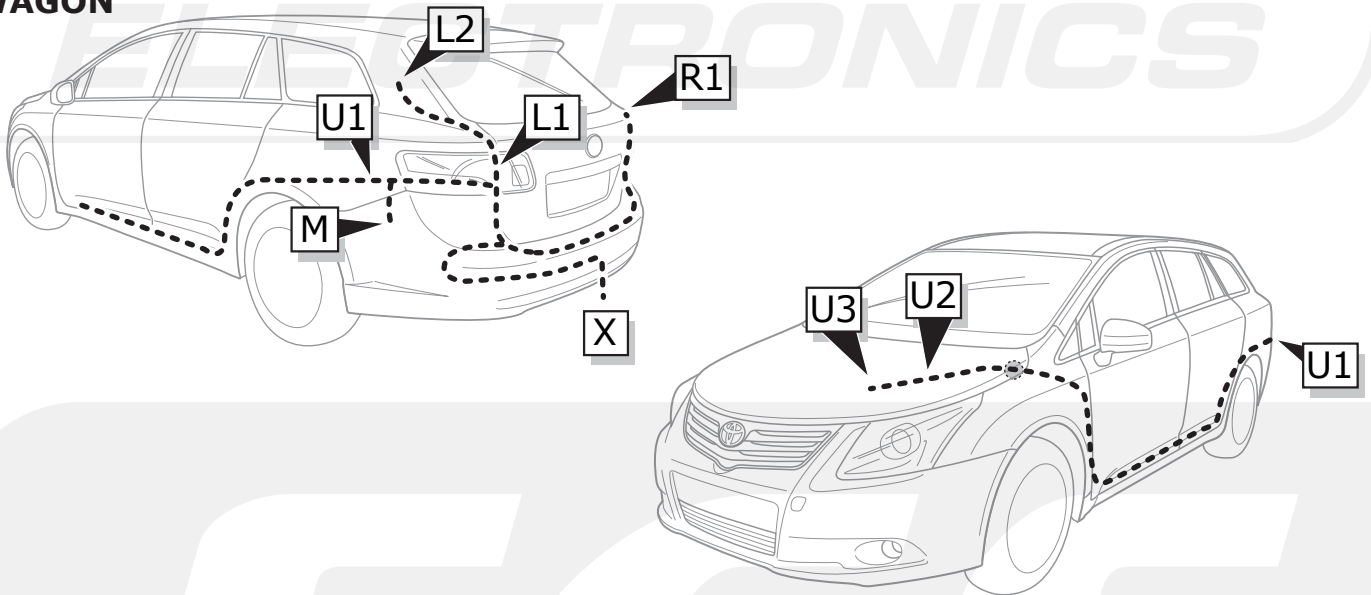

1

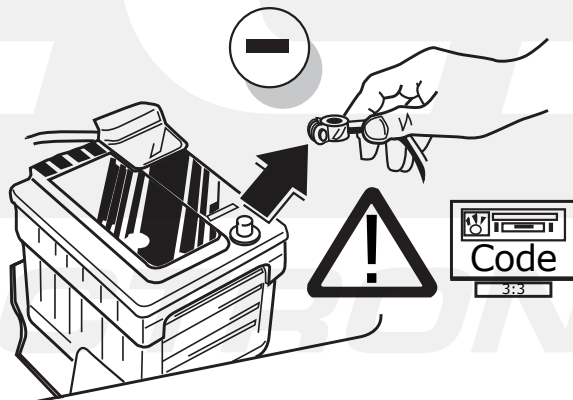

# SEDAN

2

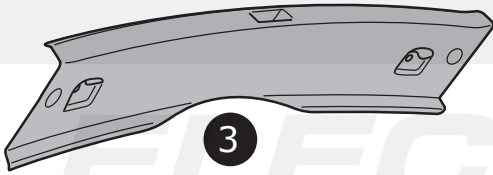
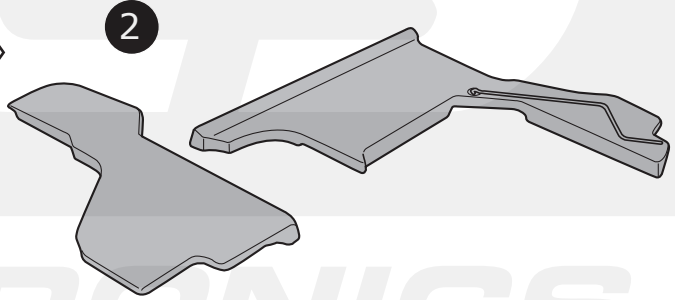
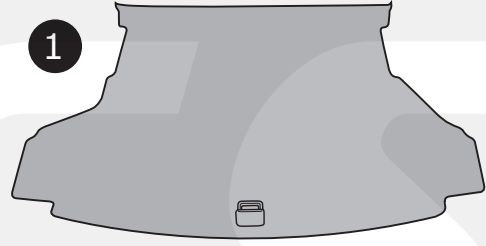
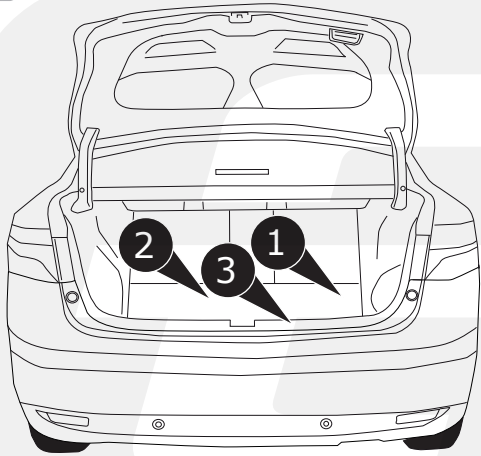

# WAGON

3

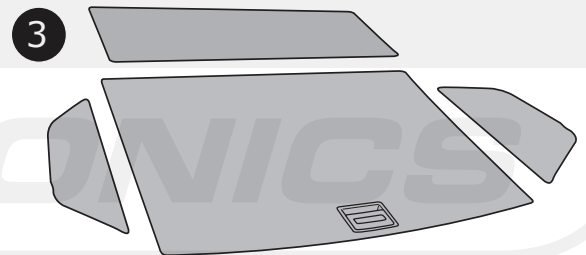
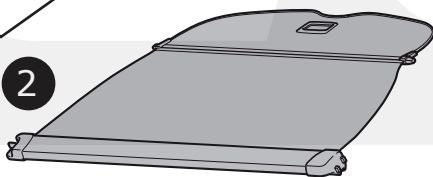
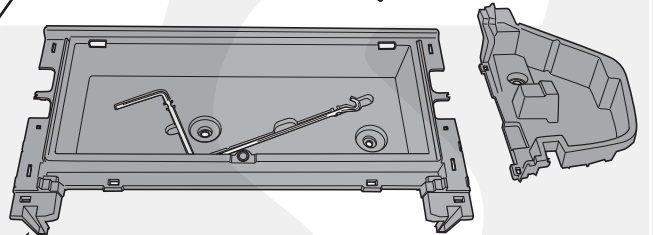
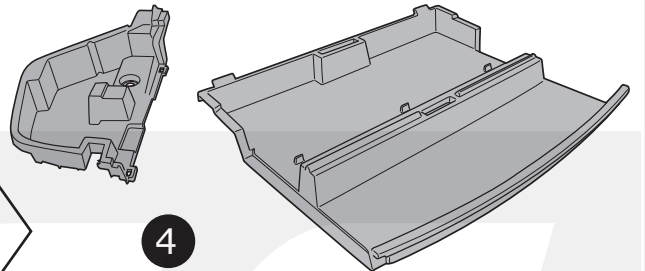
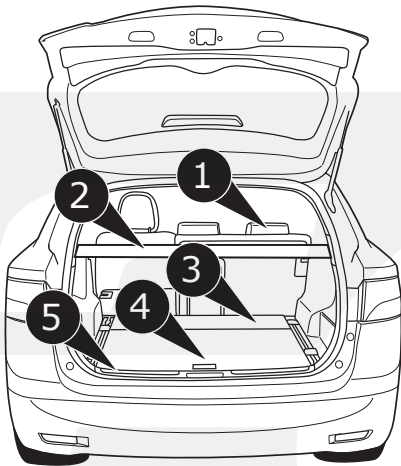

## SEDAN & WAGON

4

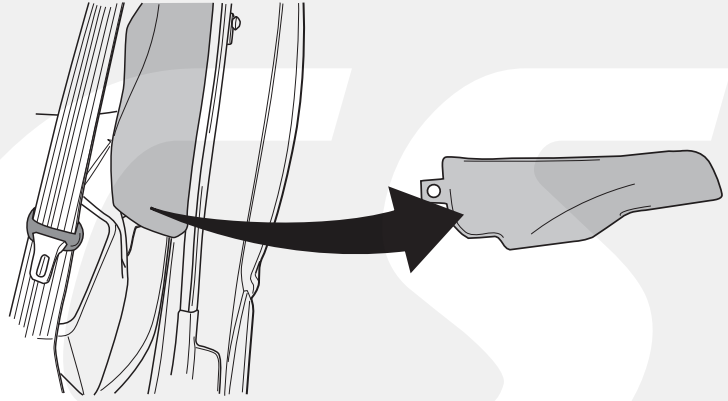
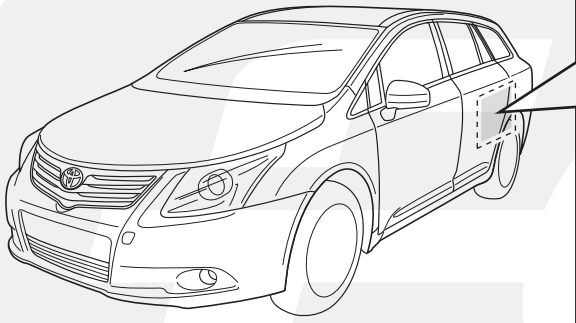

## SEDAN

5

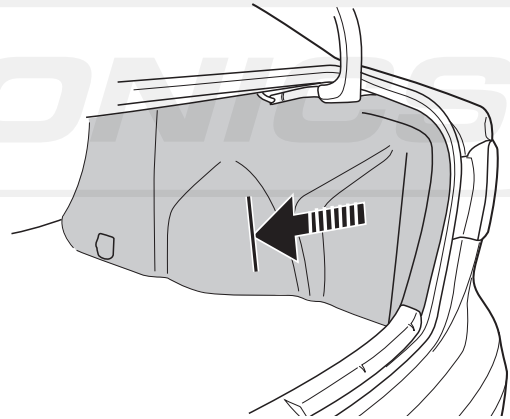
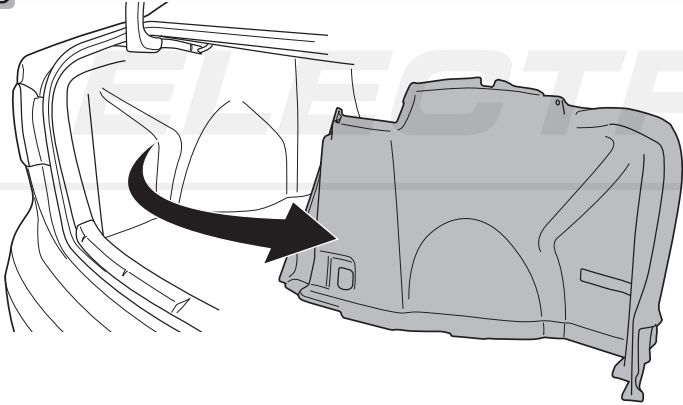

## WAGON

6

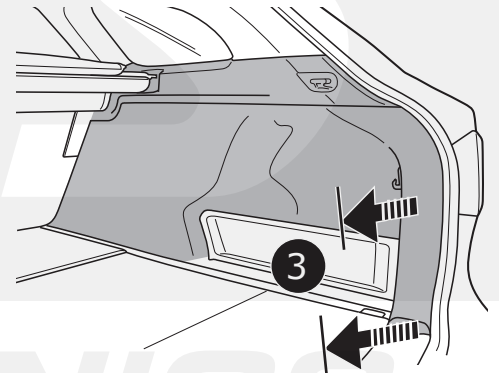
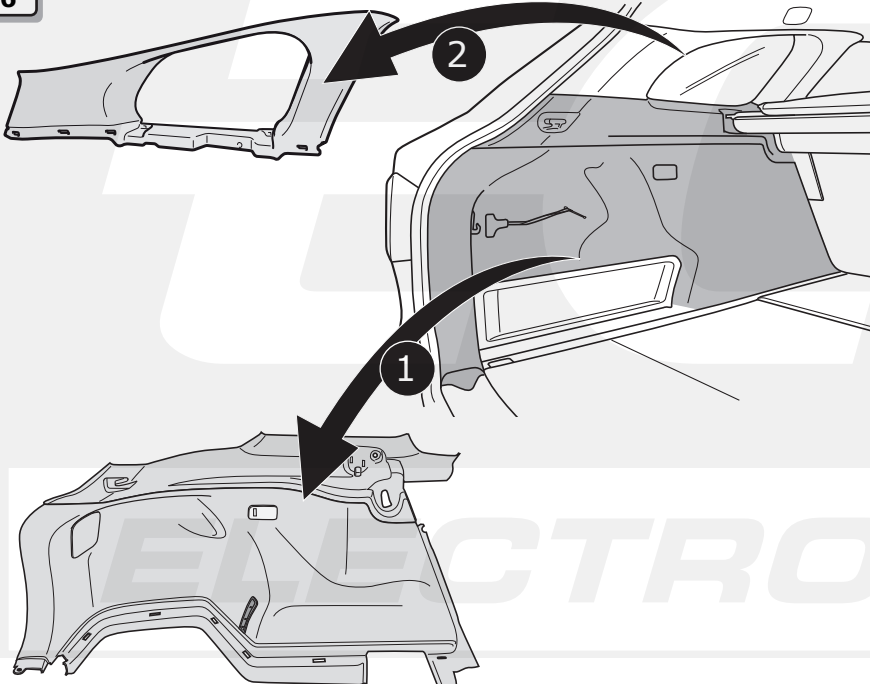

# SEDAN & WAGON

7

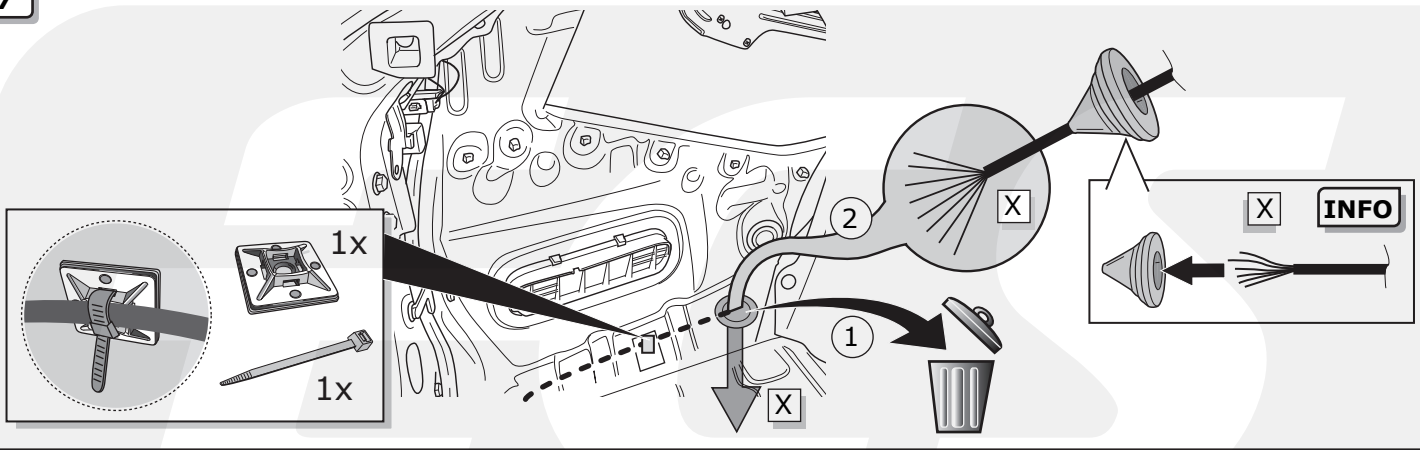

A

Option 1

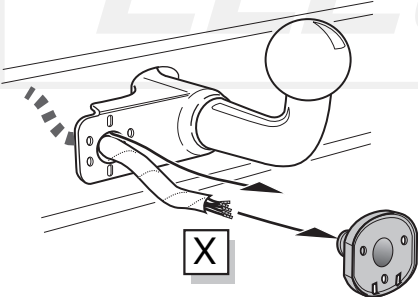

Option 2

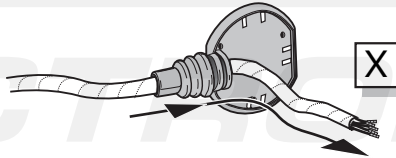

Option 3

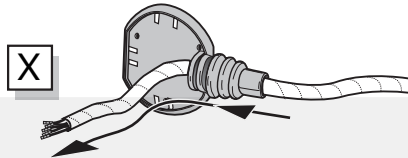

INFO

- (DE) Anschluss Steckdose
- (FR) Connection de la prise
- (NL) Contactdoos aansluiting
- (GB) Socket connection
- (ES) Conexión de la caja de enchufe
- (IT) Allaccio zoccolo
- (SE) Anslutning kontaktdosa
- (CZ) Objímkový konektor
- (DK) Stikdåse forbindelse
- (FI) Pistorasia liitäntä
- (GR) Υποδοχή σύνδεσης
- (NO) Tilkobling koblingsboks
- (PL) Połączenie przez gniazdo



Pag. 12

B

Option 1

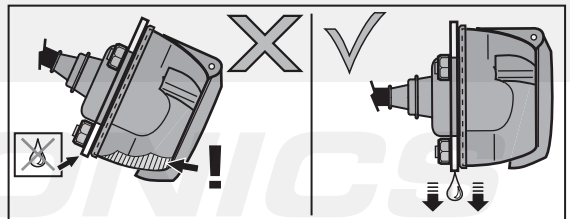
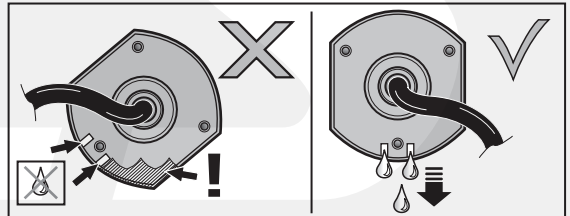
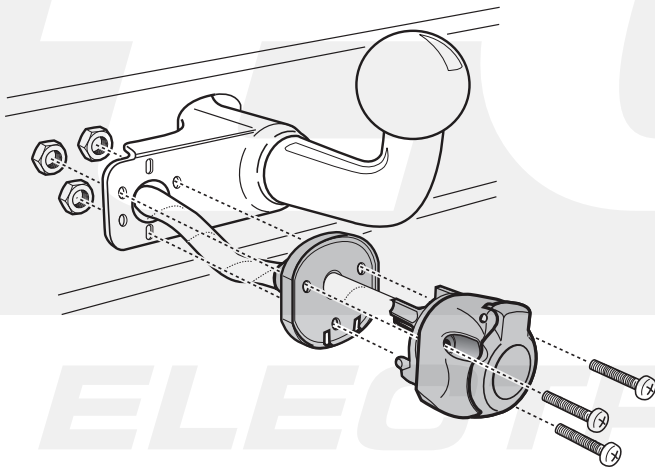

SEDAN & WAGON

C

Option 2

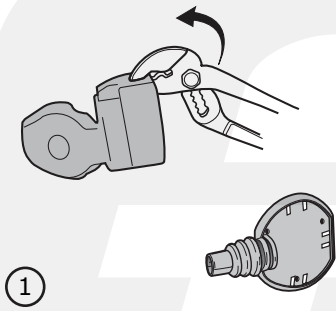

2

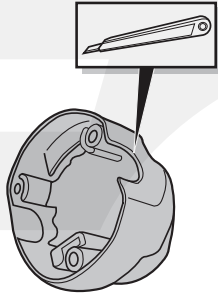

3

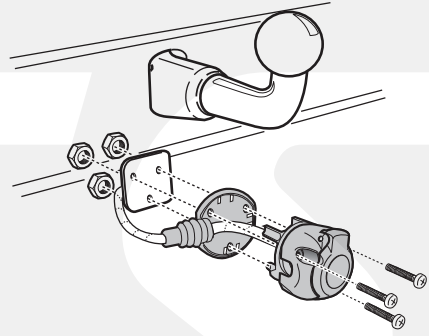

D

Option 3

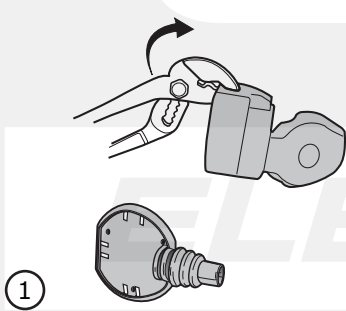

2

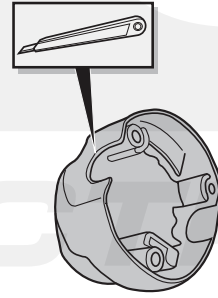

3

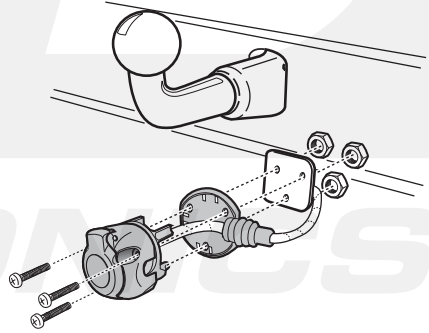

8

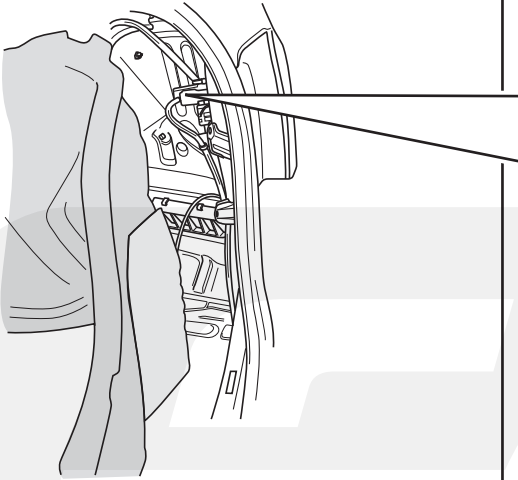

R1

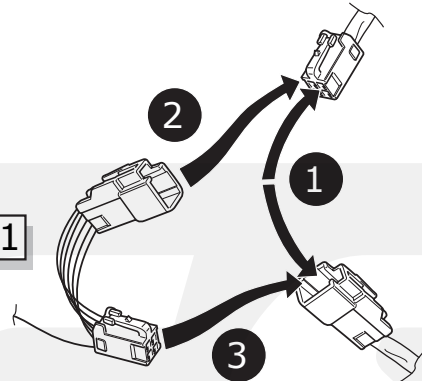

9

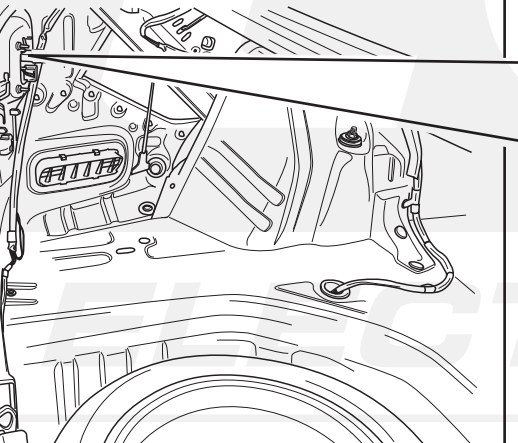

L1

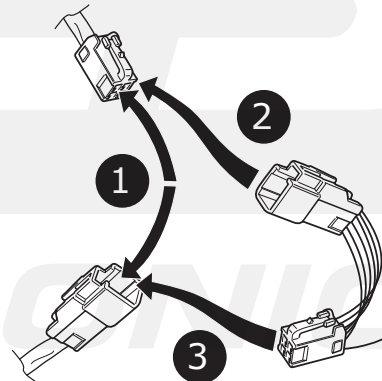

# SEDAN

10

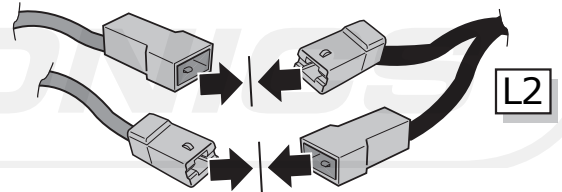
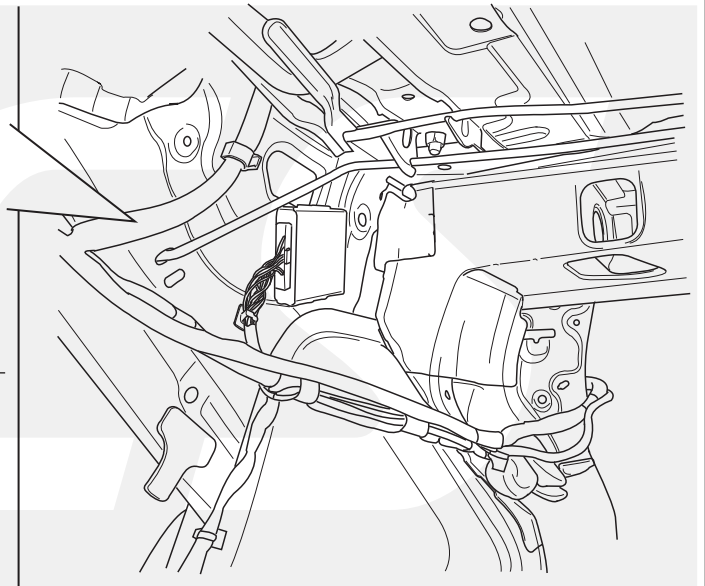
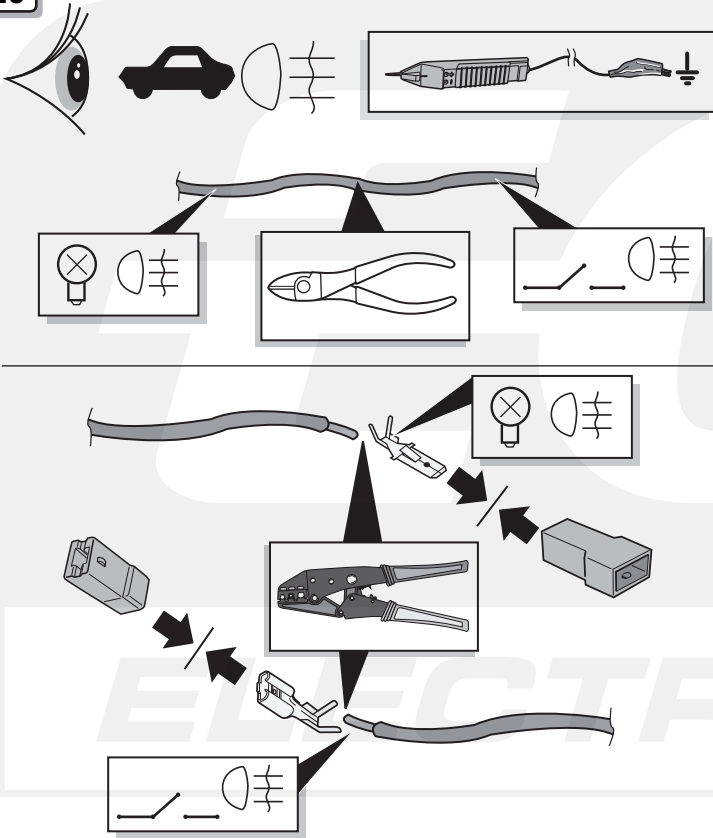

# WAGON

11

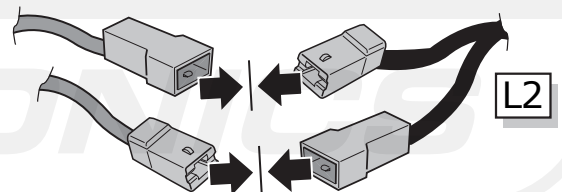
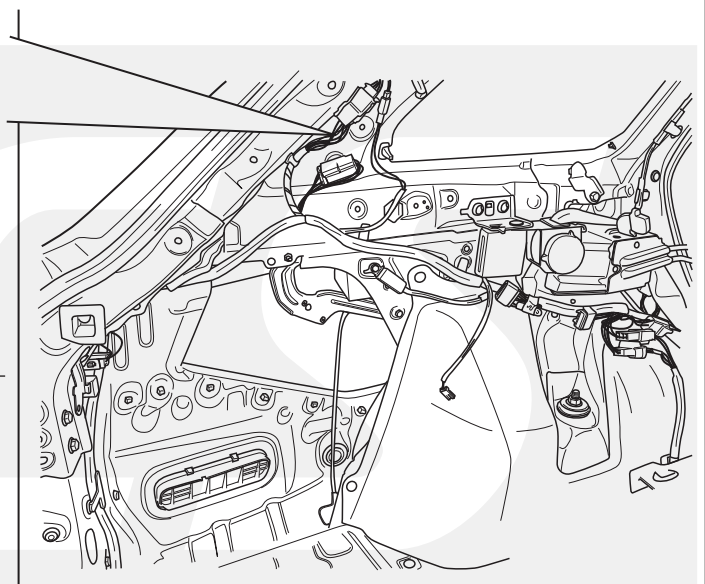
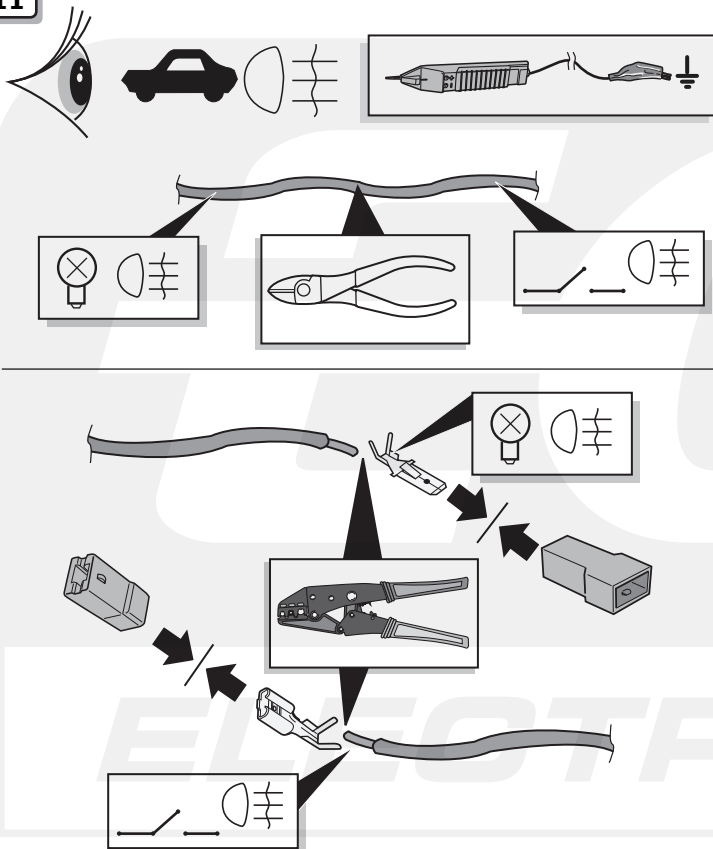



# WAGON

12

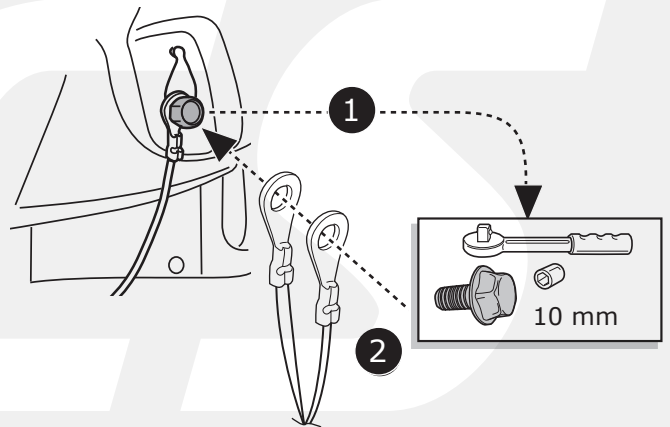
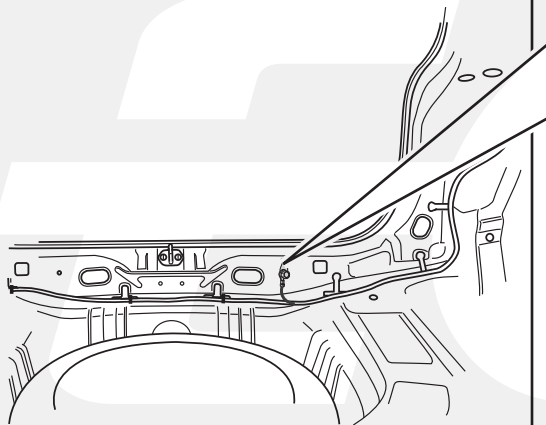

# SEDAN

13

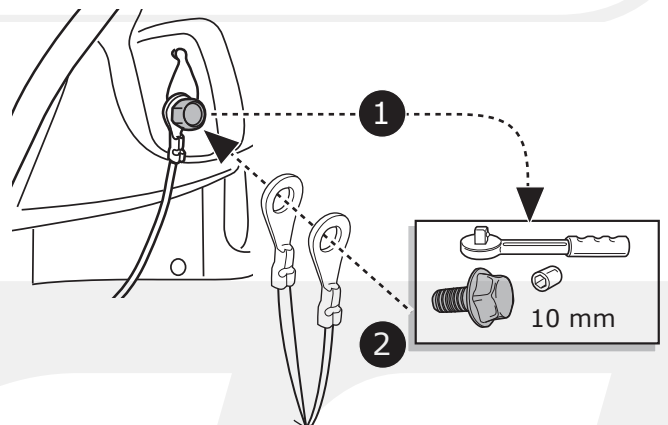
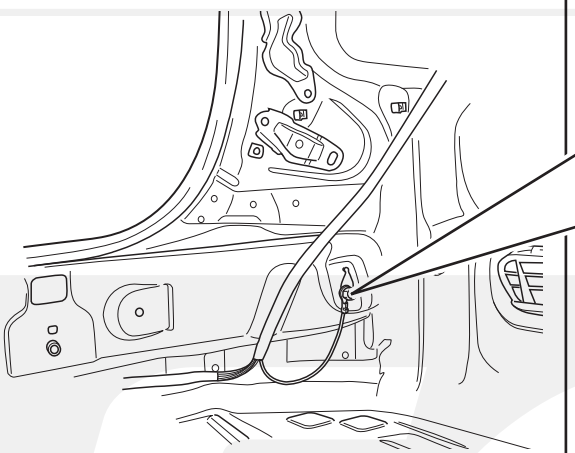

14

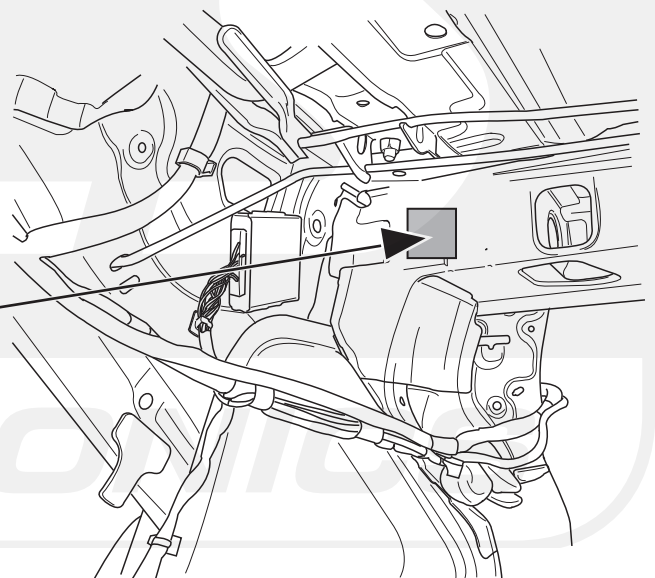
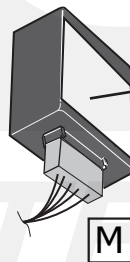
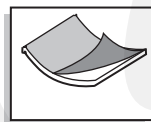
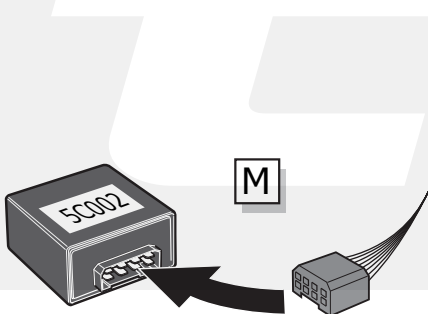

# WAGON

15

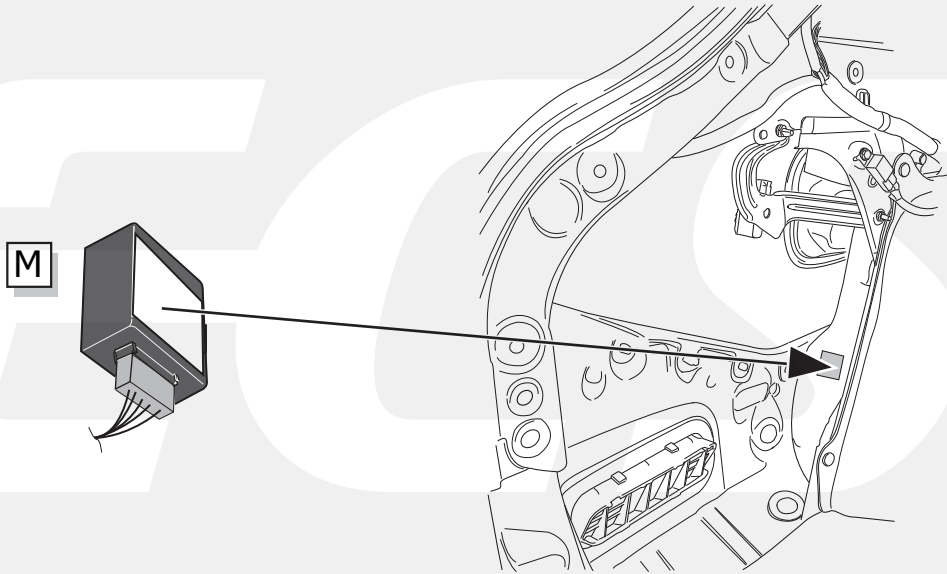

# SEDAN & WAGON

16

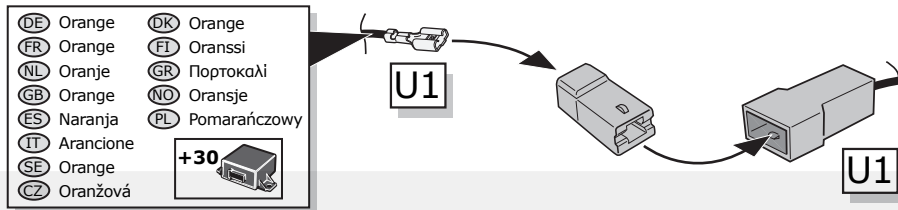

1

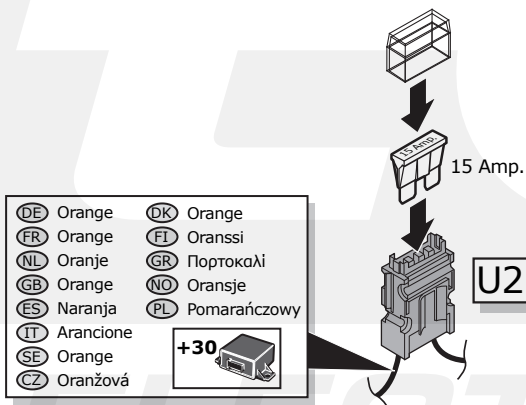

2

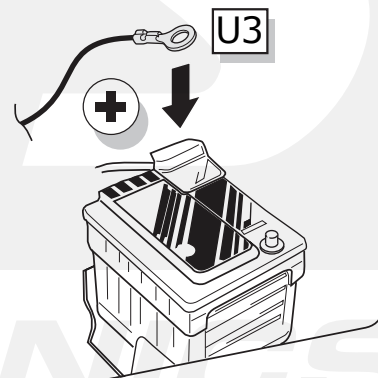

3

## SEDAN & WAGON

17

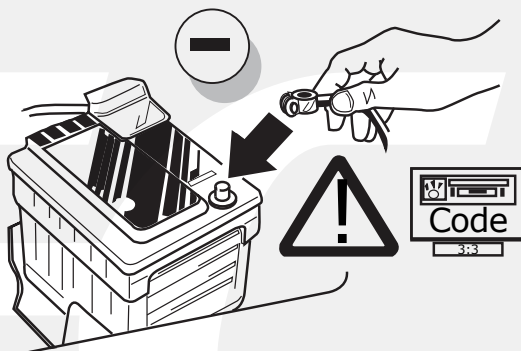

18

- |   |   |
|---|---|
| <p><b>DE</b> FUNKTIONEN KONTROLLIEREN MIT EINEM PRÜFGERÄT MIT WIDERSTAND ODER MIT LEUCHTEN MIT DER GENAUEN WATTZAHL!</p> <p><b>FR</b> CONTRÔLER LES FONCTIONS AVEC UNE BOÎTE DE TEST AVEC DE LA CHARGE OU DES LAMPES AVEC LA QUANTITÉ CORRECTE DE WATT!</p> <p><b>NL</b> CONTROLEER FUNCTIES MET EEN TESTER MET BELASTING OF LAMPEN MET DE JUISTE WATTAGE!</p> <p><b>GB</b> TEST ALL CIRCUIT FUNCTIONS WITH A TESTBOX WITH THE CORRECT POWER LOAD FOR EACH UNIT. A TESTBOX ON WHICH ONLY LEDs ARE USED CAN NOT BE USED IN THIS CASE</p> <p><b>ES</b> ¡CONTROLAR FUNCIONES CON UN TESTER CON CARGA O LUCES CON EL CORRECTO WATTAJE!</p> <p><b>IT</b> CONTROLLA FUNZIONI CON UN TESTER CON CARICO O LAMPADE DEL GIUSTO WATT-TAGGIO!</p> | <p><b>SE</b> KONTROLLERA FUNKTIONERNA MED EN TESTARE MED BELASTNING ELLER LAMPOR MED RÄTT WATT-VÄRDE!</p> <p><b>CZ</b> OVĚŘTE FUNKCE POMOČÍ TESTOVACÍHO BOXU NEBO SVĚTEL S PŘÍSLUŠNÝM VÝKONEM!</p> <p><b>DK</b> CHECK FUNKTIONERNE MED EN TESTBOKS, MED BELASTNING ELLER MED LYGTER MED DET KORREKTE ANTAL WATT!</p> <p><b>FI</b> TARKISTA TOIMINNOT KÄYTTÄMÄLLÄ TESTILAITE, JOSSA ON OIKEATEHOINEN KUORMITUS TAI OIKEATEHOISET LAMPUT!</p> <p><b>GR</b> ΕΛΕΓΕΤΕ ΤΙΣ ΛΕΙΤΟΥΡΓΙΕΣ ΜΕ ΉΝΑ ΚΙΒΩΤΙΟ ΔΟΚΙΜΗΣ ΜΕ ΦΟΡΤΙΟ Ή ΛΑΜΠΙΤΗΡΕΣ ΣΩΣΤΗΣ ΠΟΣΟΤΗΤΑΣ ΒΑΤ!</p> <p><b>NO</b> KONTROLER FUNKSJONENE MED EN TESTER MED BELASTNING ELLER LYSPÆRER MED RIKTIG WATTVERDI!</p> <p><b>PL</b> SPRAWDŹ FUNKCJE UŻYWAJĄC SKRZYŃKI TESTOWEJ Z OBCIĄŻENIEM LUB PODŁĄCZONYMI ŻARÓWKAMI O ODPOWIEDNIEJ MOCY!</p> |
|---|---|

INFO

- |                                       |   |
|---------------------------------------|---|
| <b>DE</b> Einzelteile wieder einbauen | <b>CZ</b> Znovu zasuňte obložení          |
| <b>FR</b> Montez les part enlevées    | <b>DK</b> Påsæt beklædningen              |
| <b>NL</b> Terug plaatsen onderdelen   | <b>FI</b> Asenna verhoilut takaisin       |
| <b>GB</b> Reinstall linings           | <b>GR</b> Τοποθετήστε ξανά τις επενδύσεις |
| <b>ES</b> Reinstalar componentes      | <b>NO</b> Sett tilbake deler              |
| <b>IT</b> Rimetti a posto componenti  | <b>PL</b> Założyć wykładzinę              |
| <b>SE</b> Sätt tillbaka delar         |   |

19

- DE** Gebrauchsanleitung.
- FR** Mode d'emploi.
- NL** Gebruikershandleiding.
- GB** User guide.
- ES** Guía del usuario.
- IT** Manuale di istruzioni.
- SE** Bruksanvisning.
- CZ** Uživatelská příručka.
- DK** Brugervejledning.
- FI** Käyttöohjeet.
- GR** Οδηγός χρήστη.
- NO** Brukerveiledning.
- PL** Instrukcja obsługi.

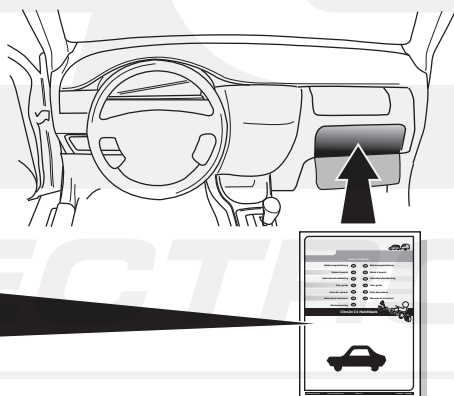







**00800**  
**CALL2ECS**  
**22 55 23 27**

09.00 - 18.00  
Monday - Friday

[www.ecs-electronics.nl](http://www.ecs-electronics.nl)

- ⓁⒹ Anschluss Steckdose
- ⓁⒹ Connection de la prise
- ⓁⒹ Contactdoos aansluiting
- ⓁⒹ Socket connection
- ⓁⒹ Conexión de la caja de enchufe
- ⓁⒹ Allaccio zoccolo
- ⓁⒹ Anslutning kontaktdosa

- ⓁⒹ Objímkový konektor
- ⓁⒹ Stikdåse forbindelse
- ⓁⒹ Pistorasia liitäntä
- ⓁⒹ Υποδοχή σύνδεσης
- ⓁⒹ Tilkobling koblingsboks
- ⓁⒹ Połączenie przez gniazdo

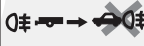
| DIN/ISO<br>1724 |  |  |  |  |  |  |  |  |
|-----------------|---|---|---|---|---|---|---|---|
|                 | 1/L   | 2   | 3/31  | 4/R   | 5/58-R  | 6/54  | 7/58-L  | 8   |
| Pmax            | 21W   | 2x21W   |   | 21W   | 52W   | 3x21W   | 52W   |   |
| ⓁⒹ              | Gelb  | Blau  | Weiß  | Grün  | Braun   | Rot   | Schwarz   | Grau  |
| ⓁⒹ              | Jaune   | Bleu  | Blanc   | Vert  | Marron  | Rouge   | Noir  | Gris  |
| ⓁⒹ              | Geel  | Blauw   | Wit   | Groen   | Bruin   | Rood  | Zwart   | Grijs   |
| ⓁⒹ              | Yellow  | Blue  | White   | Green   | Brown   | Red   | Black   | Grey  |
| ⓁⒹ              | Amarillo  | Azul  | Blanco  | Verde   | Marrón  | Rojo  | Negro   | Gris  |
| ⓁⒹ              | Giallo  | Blu   | Bianco  | Verde   | Marrone   | Rosso   | Nero  | Grigio  |
| ⓁⒹ              | Gul   | Blå   | Vit   | Grön  | Brun  | Röd   | Svart   | Grå   |
| ⓁⒹ              | Žlutá   | Modrá   | Bílá  | Zelená  | Hnědá   | Červená   | Černá   | Šedá  |
| ⓁⒹ              | Gul   | Blå   | Hvid  | Grøn  | Brun  | Rød   | Sort  | Grå   |
| ⓁⒹ              | Keltainen   | Sininen   | Valkoinen   | Vihreä  | Ruskea  | Punainen  | Musta   | Harmaa  |
| ⓁⒹ              | Κίτρινο   | Μπλε  | Λευκό   | Πράσινο   | Καφέ  | Κόκκινο   | Μαύρο   | Γκρι  |
| ⓁⒹ              | Gul   | Blå   | Hvit  | Grønn   | Brun  | Rød   | Svart   | Grå   |
| ⓁⒹ              | Żółty   | Niebieski   | Biały   | Zielony   | Brązowy   | Czerwony  | Czarny  | Szary   |